

Agilent dc Electronic Loads Models N3300A-N3307A

Technical Specifications

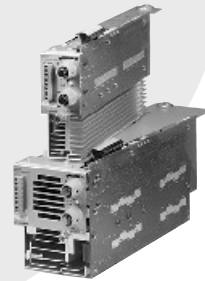

Increase your Manufacturing Test Throughput with
Fast Electronic Loads

- Increase test system throughput
- Lower cost of ownership
- Decrease system development time
- Increase system reliability
- Increase system flexibility
- Stable operation down to zero volts
- dc connection terminal for ATE applications



Agilent Technologies

Increase Test Throughput

Today's high volume manufacturing requires optimization of test system throughput, to maximize production volume without increasing floorspace. The N3300A Series electronic loads can help you in a number of ways to achieve this goal.

Reduced command processing time: Commands are processed more than 10 times faster than previous electronic loads.

Automatically execute stored command sequences: "Lists" of downloaded command sequences can execute independent of the computer, greatly reducing the electronic load command processing time and computer interaction time during product testing.

Programmable delay allows for either simultaneous or sequential load changes: This is the most efficient way to conduct testing of multiple output dc power supplies, simulating real-life loading patterns, with a minimum of programming commands.

Buffer measurement data: Voltage, current, and power measurements can be buffered for later readback to the computer, reducing computer interaction.

Control measurement speed vs. accuracy: Decrease the number of measurement samples to achieve greater measurement speed, or increase the number of samples to achieve higher measurement accuracy. You can optimize your measurements for each test.

Control rising and falling slew rates separately: Reduce rate of loading change when necessary for DUT stability or to simulate real life conditions, but otherwise change load values at maximum rate.

Increase System Flexibility...for both present and future requirements

Most power supply and battery charger test systems designed today need to test a variety of products and/or assemblies. In the future, additional products or assemblies may be needed. A flexible family of electronic loads makes present system design and future growth much easier.

Test low voltage power supplies: The N3300A series electronic loads operate with full stability down to zero volts. Many other electronic loads available today have been found to become unstable in the operating region below one volt. When designing power supply test platforms, the trend towards lower voltage requirements should be taken into account. Refer to the specification and supplemental characteristic tables for details of lower voltage operating characteristics.

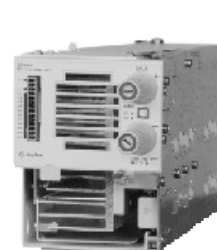

Standard dc connectors

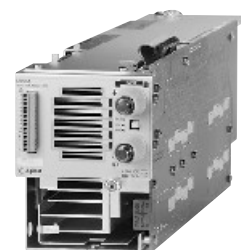

Option UJ1 8 mm screw connectors

Choose dc load connection method:

Automatic test systems need consistency and reliability. Option UJ1 8 mm screw connectors provide a simple screw onto which your wires, terminated with insulated ring terminals, may be securely mounted. This optional connector is specifically designed for test systems. Wires may exit the plastic cover in any direction, and multiple wires may be placed on each screw terminal for easy parallel load connections. Up to AWG 4 wire may be used.

Applications which require repeated connections/disconnections are better suited to the standard connector. The standard connector accepts an unterminated wire, and may be hand-tightened. This connector is specifically designed for bench applications and short-term automated tests.

Design a system to test a variety of products:

This series consists of 2 mainframes and 6 modules. The N3300A mainframe is full rack width. It has 6 slots. The N3301A mainframe is half rack width. It has 2 slots. Any assortment of the 6 different modules can be configured into these mainframes, up to the slot capacity. The N3302A (150 watts), N3303A (250 watts), N3307A (250 Watts) and N3304A (300 watts) each

require one slot. The N3305A (500 watts) and the N3306A (600 watts) each require 2 slots. The electronic load can be configured to supply exactly what you need now, and this modular design also allows for easy future reconfiguration.

Test high current power supplies: Electronic load modules can be operated in parallel to provide additional current sinking capability.

Control the electronic load how you want to: GPIB, RS232, and manual use of the front panel all provide complete control of these electronic loads. There are also analog programming and monitoring ports for those applications that utilize non-standard interfaces, require custom waveforms, or utilize process control signals. Custom waveforms can also be created by downloading a “List” of load parameters. In addition, there is a built-in transient generator, which operates in all modes.

Quickly create powerful and consistent software: All Agilent Technologies electronic loads use the SCPI (Standard Commands for Programmable Instruments) command set. This makes learning the commands easy, because they are the same format as all other SCPI instruments. The resulting code is virtually self-documenting, and therefore easier to troubleshoot and modify in the future. *Plug-n-Play* drivers are

also available to help you to integrate the loads into your standard software packages.

Make Measurements Easily and Accurately

The 16-bit voltage, current and power measurement system provides both accuracy and convenience. The alternative is using a dmm (digital multimeter) and MUX (multiplexer) along with a precision current shunt and a lot of extra wiring. Avoiding this complexity increases system reliability and makes the system easier to design and support. Current measurements in particular are more consistently accurate using the electronic load’s internal system, because the wiring associated with an external precision current shunt may pick up noise.

Measure with all load modules simultaneously: Testing multiple-output dc power supplies and dc-dc converters can be very time consuming if each output must be tested sequentially. If measurements are being made through a MUX using one DMM, this is what will happen. Using the built-in measurement capabilities of the N3300A electronic loads, all outputs can be measured simultaneously. Alternatively, multiple single output power sources can be tested simultaneously.

Measure voltage and current simultaneously: The N3300A measurement system has individual but linked current and voltage measurement systems. This means that voltage and current measurements are taken exactly simultaneously, which gives a true picture of the power supply under test’s output at a particular moment in time. Some other electronic loads which feature internal measurement systems actually take current and voltage measurements sequentially, and therefore do not give as accurate a picture of momentary power.

Observe transient behavior using waveform digitization: Transient response and other dynamic tests often require an oscilloscope. The N3300A has a flexible waveform digitizer with a 4096 data point buffer for voltage and a 4096 data point buffer for current. Under many circumstances, this internal digitizer will be adequate for power supply test needs. Current and voltage are digitized simultaneously, and the sampling rate and sample window are programmable. Some analysis functions are provided, including RMS, max and min.

Specifications

Table A-1

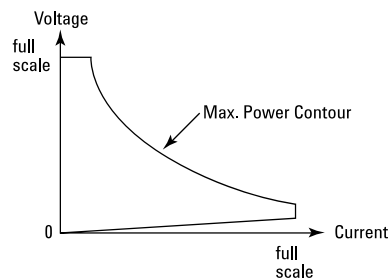

Table A-1 lists the specifications for the different load models. Specifications indicate warranted performance in the 25°C ±5°C region of the operating temperature range. Specifications apply to normal and transient modes unless otherwise noted.

	N3302A	N3303A	N3304A	N3305A	N3306A	N3307A
Input Ratings						
Current	0 - 30 A	0 - 10 A	0 - 60 A	0 - 60 A	0 - 120 A	0 - 30 A
Voltage	0 - 60 V	0 - 240 V	0 - 60 V	0 - 150 V	0 - 60 V	0 - 150 V
Maximum Power @ 40°C ¹	150 W	250 W	300 W	500 W	600 W	250 W

Input Characteristic

Operating Contour



Derated Current Detail

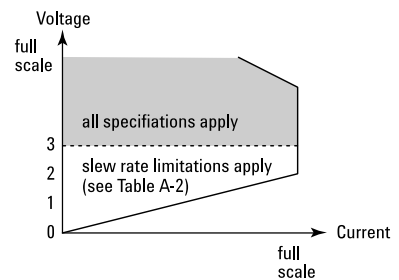

Specified Current @ Low Voltage Operation

2.0 V	30 A	10 A	60 A	60 A	120 A	30 A
1.5 V	22.5 A	7.5 A	45 A	45 A	90 A	22.5 A
1.0 V	15 A	5 A	30 A	30 A	60 A	15 A
0.5 V	7.5 A	2.5 A	15 A	15 A	30 A	7.5 A
0 V	0 A	0 A	0 A	0 A	0 A	0 A

¹ Maximum continuous power available is derated linearly from 100% of maximum at 40°C, to 75% of maximum at 55°C.

Typical Minimum Operating Voltage @ Full Scale Current

	N3302A	N3303A	N3304A	N3305A	N3306A	N3307A
Table A-1 states that maximum current is available down to 2 volts. Typically, however under normal operating conditions, the load can sink the maximum current down to the following voltages:	1.2 V	1.2 V	1.2 V	1.4 V	1.4 V	1.4 V

Table A-1 Specifications (continued)

	N3302A	N3303A	N3304A	N3305A	N3306A	N3307A
Constant Current Mode²						
Low Range/High Range	3 A/30 A	1 A/10 A	6 A/60 A	6 A/60 A	12 A/120 A	3 A/30 A
Regulation	10 mA	8 mA	10 mA	10 mA	10 mA	10 mA
Low Range Accuracy	0.1% + 5 mA	0.1% + 4 mA	0.1% + 7.5 mA	0.1% + 7.5 mA	0.1% + 15 mA	0.1% + 7.5 mA
High Range Accuracy	0.1% + 10 mA	0.1% + 7.5 mA	0.1% + 15 mA	0.1% + 15 mA	0.1% + 37.5 mA	0.1% + 15 mA
Constant Voltage Mode²						
Low Range/High Range	6 V/60 V	24 V/240 V	6 V/60V	15 V/150 V	6 V/60 V	15 V/150 V
Regulation	5 mV	10 mV	10 mV	10 mV	20 mV	10 mV
Low Range Accuracy	0.1% + 3 mV	0.1% + 10 mV	0.1% + 3 mV	0.1% + 10 mV	0.1% + 3 mV	0.1% + 10 mV
High Range Accuracy	0.1% + 8 mV	0.1% + 40 mV	0.1% + 8 mV	0.1% + 20 mV	0.1% + 8 mV	0.1% + 20 mV
Constant Resistance Mode²						
Range 1 (I > 10% of current rating)	0.067-4 Ω	0.2-48 Ω	0.033-2 Ω	0.033-5 Ω	0.017-1 Ω	0.067-10 Ω
Range 2 (I > 1% of current rating)	3.6-40 Ω	44-480 Ω	1.8-20 Ω	4.5-50 Ω	0.9-10 Ω	9-100 Ω
Range 3 (I > 0.1% of current rating)	36-400 Ω	440-4800 Ω	18-200 Ω	45-500 Ω	9-100 Ω	90-1000 Ω
Range 4 (I > 0.01% of current rating)	360-2000 Ω	4400-12000 Ω	180-2000 Ω	450-2500 Ω	90-1000 Ω	900-2500 Ω
Transient Generator						
Frequency Range	0.25 Hz - 10 kHz	0.25 Hz - 10 kHz	0.25 Hz - 10 kHz	0.25 Hz - 10 kHz	0.25 Hz - 10 kHz	0.25 Hz - 10 kHz
Pulse Width	50 μs ±1% to 4 seconds ±1%	50 μs ±1% to 4 seconds ±1%	50 μs ±1% to 4 seconds ±1%	50 μs ±1% to 4 seconds ±1%	50 μs ±1% to 4 seconds ±1%	50 μs ±1% to 4 seconds ±1%
Current Measurement²						
Low Range/High Range	3 A/30 A	1 A/10 A	6 A/60 A	6 A/60 A	12 A/120 A	3 A/30 A
Low Range Accuracy ³	0.05% + 3 mA	0.05% + 2.5 mA	0.05% + 5 mA	0.05% + 5 mA	0.05% + 10 mA	0.05% + 3 mA
High Range Accuracy ³	0.05% + 6 mA	0.05% + 5 mA	0.05% + 10 mA	0.05% + 10 mA	0.05% + 20 mA	0.05% + 6 mA
Voltage Measurement²						
Low Range/High Range	6 V/60 V	24 V/240 V	6 V/60 V	15 V/150 V	6 V/60 V	15 V/150 V
Low Range Accuracy	0.05% + 3 mV	0.05% + 10 mV	0.05% + 3 mV	0.05% + 8 mV	0.05% + 3 mV	0.05% + 8 mV
High Range Accuracy	0.05% + 8 mV	0.05% + 20 mV	0.05% + 8 mV	0.05% + 16 mV	0.05% + 8 mV	0.05% + 16 mV
Power Measurement²						
Accuracy	0.1% + 0.5 W	0.1% + 1.2 W	0.1% + 0.5 W	0.1% + 1.5 W	0.1% + 1.2 W	0.1% + 0.5 W

² Specification is ±(% of reading + fixed offset). Measurement is 1000 samples. Specification may degrade when the unit is subject to an RF field of 3 V/meter, the unit is subject to line spikes of 500 V, or an 8 kV electrostatic discharge.

³ dc current accuracy specifications apply 30 seconds after input current is applied.

Supplemental Characteristics

Table A-2 lists the supplemental characteristics, which are not warranted but are descriptions of typical performance determined either by design or type testing.

Table A-2

		N3302A	N3303A	N3304A	N3305A	N3306A	N3307A
Programming Resolution							
	Constant Current Mode	0.05 mA/0.5 mA	0.02 mA/0.2 mA	0.1 mA/1 mA	0.1 mA/1 mA	0.2 mA/2 mA	0.05 mA/0.5 mA
	Constant Voltage Mode	0.1 mV/1 mV	0.4 mV/4 mV	0.1 mV/1 mV	0.25 mV/2.5 mV	0.1 mV/1 mV	0.25 mV/2.5 mV
	Constant Resistance Mode	0.07/0.7/7/70 mΩ	0.82/8.2/82 mΩ	0.035/0.35/3.5/35 mΩ	0.085/0.85/8.5/85 mΩ	0.0175/0.175/1.75/17.5 mΩ	0.17/1.7/17/170 mΩ
Readback Resolution							
	Current	0.05 mA/0.5 mA	0.02 mA/0.2 mA	0.1 mA/1 mA	0.1 mA/1 mA	0.2 mA/2 mA	0.05 mA/0.5 mA
	Voltage	0.1 mV/1 mV	0.4 mV/4 mV	0.1 mV/1 mV	0.25 mV/2.5 mV	0.1 mV/1 mV	0.25 mV/2.5 mV
Programmable Slew Rate¹							
Current Ranges	Slow band	500 A/s - 25 kA/s	167 A/s - 8330 A/s	1 kA/s - 50 kA/s	1 kA/s - 50 kA/s	2 kA/s - 100 kA/s	500 A/s - 25 kA/s
	Fast band ≥3 V	50 kA/s - 2.5 MA/s	16.7 kA/s - 833 kA/s	100 kA/s - 5 MA/s	100 kA/s - 5 MA/s	200 kA/s - 10 MA/s	50 kA/s - 2.5 MA/s
	Fast band <3 V	50 kA/s - 250 kA/s	16.7 kA/s - 83.3 kA/s	100 kA/s - 500 kA/s	100 kA/s - 500 kA/s	200 kA/s - 1 MA/s	50 kA/s - 250 kA/a
Voltage Ranges	Slow band	1 kV/s - 50 kV/s	4 kV/s - 200 kV/s	1 kV/s - 50 kV/s	2.5 kV/s - 125 kV/s	1 kV/s - 50 kV/s	2.5 kV/s - 125 kV/s
	Fast band ≥3 V	100 kV/s - 500 kV/s	400 kV/s - 2 MV/s	100 kV/s - 500 kV/s	250 kV/s - 1.25 MV/s	100 kV/s - 500 kV/s	250 kV/s - 1.25 MV/s
	Fast band <3 V	100 kV/s - 50 kV/s	400 kV/s - 200 kV/s	100 kV/s - 50 kV/s	250 kV/s - 125 kV/s	100 kV/s - 50 kV/s	250 kV/s - 125 kV/s
Resistance Range 1	Slow band	44 Ω/s - 1125 Ω/s	540 Ω/s - 13.5 kΩ/s	22 Ω/s - 560 Ω/s	55 Ω/s - 1400 Ω/s	11 Ω/s - 280 Ω/s	110 Ω/s - 2800 Ω/s
	Fast band ≥3 V	2250 Ω/s - 34 kΩ/s	27 kΩ/s - 408 kΩ/s	1120 Ω/s - 17 kΩ/s	2800 Ω/s - 42.5 kΩ/s	560 Ω/s - 8.5 kΩ/s	5600 Ω/s - 85 kΩ/s
	Fast band <3 V	2250 Ω/s - 3.4 kΩ/s	27 kΩ/s - 40.8 kΩ/s	1120 Ω/s - 1.7 kΩ/s	2800 Ω/s - 4.25 kΩ/s	560 Ω/s - 850 Ω/s	5600 Ω/s - 8.5 kΩ/s
Resistance Range 2	Slow band	440 Ω/s - 11.25 kΩ/s	5.4 kΩ/s - 135 kΩ/s	220 Ω/s - 5600 Ω/s	550 Ω/s - 14 kΩ/s	110 Ω/s - 2800 Ω/s	1.1 kΩ/s - 28 kΩ/s
	Fast band ≥3 V	22.5 kΩ/s - 340 kΩ/s	270 kΩ/s - 4.08 MΩ/s	11.2 kΩ/s - 170 kΩ/s	28 kΩ/s - 425 kΩ/s	5600 Ω/s - 85 kΩ/s	56 kΩ/s - 850 kΩ/s
	Fast band <3 V	22.5 kΩ/s - 34 kΩ/s	270 kΩ/s - 408 kΩ/s	11.2 kΩ/s - 17 kΩ/s	28 kΩ/s - 42.5 kΩ/s	5600 Ω/s - 8.5 kΩ/s	56 kΩ/s - 85 kΩ/s
Resistance Range 3	Slow band	4.4 kΩ/s - 112.5 kΩ/s	54 kΩ/s - 1.35 MΩ/s	2.2 kΩ/s - 56 kΩ/s	5.5 kΩ/s - 140 kΩ/s	1.1 kΩ/s - 28 kΩ/s	11 kΩ/s - 280 kΩ/s
	Fast band ≥3 V	225 kΩ/s - 3.4 MΩ/s	2.7 MΩ/s - 40.8 MΩ/s	112 kΩ/s - 1.7 MΩ/s	280 kΩ/s - 4.25 MΩ/s	56 kΩ/s - 850 kΩ/s	560 kΩ/s - 8.5 MΩ/s
	Fast band <3 V	225 kΩ/s - 340 kΩ/s	2.7 MΩ/s - 4.08 MΩ/s	112 kΩ/s - 170 kΩ/s	280 kΩ/s - 425 kΩ/s	56 kΩ/s - 85 kΩ/s	560 kΩ/s - 850 kΩ/s
Resistance Range 4	Slow band	44 kΩ/s - 1.125 MΩ/s	540 kΩ/s - 13.5 MΩ/s	22 kΩ/s - 560 kΩ/s	55 kΩ/s - 1.4 MΩ/s	11 kΩ/s - 280 kΩ/s	110 kΩ/s - 2.8 MΩ/s
	Fast band ≥3 V	2.25 MΩ/s - 34 MΩ/s	27 MΩ/s - 408 MΩ/s	1.12 MΩ/s - 17 MΩ/s	2.8 MΩ/s - 42.5 MΩ/s	560 kΩ/s - 8.5 MΩ/s	5.6 MΩ/s - 85 MΩ/s
	Fast band <3 V	2.25 MΩ/s - 3.4 MΩ/s	27 MΩ/s - 40.8 MΩ/s	1.12 MΩ/s - 1.7 MΩ/s	2.8 MΩ/s - 4.25 MΩ/s	560 kΩ/s - 850 kΩ/s	5.6 MΩ/s - 8.5 MΩ/s
Programmable Short		66 mΩ max.	200 mΩ max.	33 mΩ max.	33 mΩ max.	17 mΩ max.	33 mΩ max.
		40 mΩ typical	100 mΩ typical	20 mΩ typical	25 mΩ typical	12 mΩ typical	20 mΩ typical
Programmable Open		≥20 kΩ	≥80 kΩ	≥20 kΩ	≥20 kΩ	≥20 kΩ	≥80 kΩ

¹ Slew rate bands are the ranges of programmable slew rates available. When you program a slew rate value outside the indicated bands, the electronic load will automatically adjust the slew rate to fit within the band that is closest to the programmed value. It is not necessary to specify the band, only the slew rate itself.

Below 3 volts, the maximum bandwidth of the electronic load is reduced by a factor of ten to one. For example, in the current range for Model N3302A, the maximum slew rate is specified as 2.5 MA/s, below 3 volts the maximum slew rate would be 250 kA/s. Any slew rate programmed between 2.5 MA/s and 250 kA/s would produce a slew rate of 250 k/s. Slew rates programmed slower than 250 kA/s would still correctly reflect their programmed value. Note that if you are using transient mode to generate a high frequency pulse train, a reduced slew rate might cause the load to never reach the upper programmed value before beginning the transition to the lower programmed value. So even though the transient mode is still operational at lower voltages, a fast pulse train with large transitions may not be achievable.

Table A-2. Supplemental Characteristics (continued)

	N3302A	N3303A	N3304A	N3305A	N3306A	N3307A
Command Processing Time						
Using discrete commands	3 ms	3 ms	3 ms	3 ms	3 ms	3 ms
Using List commands	1 ms	1 ms	1 ms	1 ms	1 ms	1 ms
List Dwell Characteristics						
Range	0 - 10 s	0 - 10 s	0 - 10 s	0 - 10 s	0 - 10 s	0 - 10 s
Resolution	1 ms	1 ms	1 ms	1 ms	1 ms	1 ms
Accuracy	5 ms	5 ms	5 ms	5 ms	5 ms	5 ms
Measurement Time						
1000 samples (default)	20 ms (with specified measurement accuracy)	20 ms (with specified measurement accuracy)	20 ms (with specified measurement accuracy)	20 ms (with specified measurement accuracy)	20 ms (with specified measurement accuracy)	20 ms (with specified measurement accuracy)
200 samples	10 ms (with <6% additional fixed offset)	10 ms (with <6% additional fixed offset)	10 ms (with <6% additional fixed offset)	10 ms (with <6% additional fixed offset)	10 ms (with <6% additional fixed offset)	10 ms (with <6% additional fixed offset)
100 samples	9 ms (with <10% additional fixed offset)	9 ms (with <10% additional fixed offset)	9 ms (with <10% additional fixed offset)	9 ms (with <10% additional fixed offset)	9 ms (with <10% additional fixed offset)	9 ms (with <10% additional fixed offset)
20 points	7 ms (with <30% additional fixed offset)	7 ms (with <30% additional fixed offset)	7 ms (with <30% additional fixed offset)	7 ms (with <30% additional fixed offset)	7 ms (with <30% additional fixed offset)	7 ms (with <30% additional fixed offset)
<20 points	7 ms (with >30% additional fixed offset)	7 ms (with >30% additional fixed offset)	7 ms (with >30% additional fixed offset)	7 ms (with >30% additional fixed offset)	7 ms (with >30% additional fixed offset)	7 ms (with >30% additional fixed offset)
Ripple and Noise (20 Hz - 10 MHz)						
Current (rms/peak to peak)	2 mA/20 mA	1 mA/10 mA	4 mA/40 mA	4 mA/40 mA	6 mA/60 mA	2 mA/20 mA
Voltage (rms)	5 mV _{rms}	12 mV _{rms}	6 mV _{rms}	10 mV _{rms}	8 mV _{rms}	10 mV _{rms}
External Analog Programming						
Voltage Programming Accuracy ²	0.5% + 12 mV	0.5% + 48 mV	0.5% + 12 mV	0.5% + 30 mV	0.5% + 12 mV	0.5% + 30 mV
Current Programming Accuracy ²	0.25% + 4.5 mA	0.25% + 1.5 mA	0.25% + 9 mA	0.25% + 9 mA	0.25% + 18 mA	0.25% + 4.5 mA
External Monitor Ports						
Voltage Monitor Accuracy	0.25% + 12 mV	0.25% + 48 mV	0.25% + 12 mV	0.25% + 30 mV	0.25% + 12 mV	0.25% + 30 mV
Current Monitor Accuracy	0.1% + 4.5 mA	0.1% + 1.5 mA	0.1% + 9 mA	0.1% + 9 mA	0.1% + 18 mA	0.1% + 4.5 mA

² Applies to all ranges.

Supplemental Characteristics

Table A-3

	N3300A	N3301A
Operating Temperature Range	0°C to 55°C	0°C to 55°C
Input Ratings		
Operating range	100 - 250 Vac; 48 - 63 Hz	100 - 250 Vac; 48 - 63 Hz
Input Current	4.2 A @ 100 - 127 Vac; 2.2 A @ 200 - 250 Vac	2.3 A @ 100 - 250 Vac
Input VA	440 VA	230 VA
Inrush Current	38 A	18 A @ 115 Vac; 36 A @ 230 Vac

Supplemental Characteristics Continued

Analog Programming Bandwidth:

10 kHz (-3 db frequency)

Analog Programming Voltage:

Voltage: 0 - 10 V

Current: 0 - 10 V

Analog Monitor Ports:

Voltage: 0 - 10 V

Current: 0 - 10 V

Remote Sensing:

5 V dc between sense and load input

Digital/Trigger Inputs

Vil = 0.9 V max at Iil = -1 mA

Vih = 3.15 V min (pull-up resistor on input)

Digital/Trigger Outputs

Vol = 0.72 V max at Iol = 1 mA

Voh = 4.4 V min at Ioh = -20 µA

Net Weight:

N3300A: 13.2 kg (29 lb);

N3301A: 7.3 kg (16 lb);

N3302A, N3303A, N3304A or

N3307A: 2.7 kg (6 lb);

N3305A or N3306A: 4.6 kg (10 lb)

Shipping Weight:

N3300A: 17 kg (38 lb); N3301A: 9.1 kg (20 lb)

N3302A, N3303A, N3304A or

N3307A: 4.1 kg (9 lb)

N3305A or N3306A: 6.8 kg (15 lb)

Option Descriptions

Opt. UJ1:

8 mm screw terminal connector

Opt. 800:

Rack-mount kit for two N3301A Mainframes mounted side-by-side (p/n 5061-9694 and 5062-3978).

Opt. 908:

Rack-mount kit (Two p/n 5062-3974 for a N3300A, or p/n 5062-3960 for one N3301A). For the N3301A, the kit includes a blank filler panel.

Opt. 909:

Rack-mount kit with handles for N3300A (Two p/n 5062-3975)

Opt. 910:

Extra manual set, including one each of the operating manual, programming reference manual, and service manual. The programming manual is available with the mainframes, and therefore not with the modules.

Note:

Options 908, 909, and 800 require either the slide kit (p/n 1494-0059) or support rails (E3663AC) to support the weight of the load mainframe.

Agilent N3300A

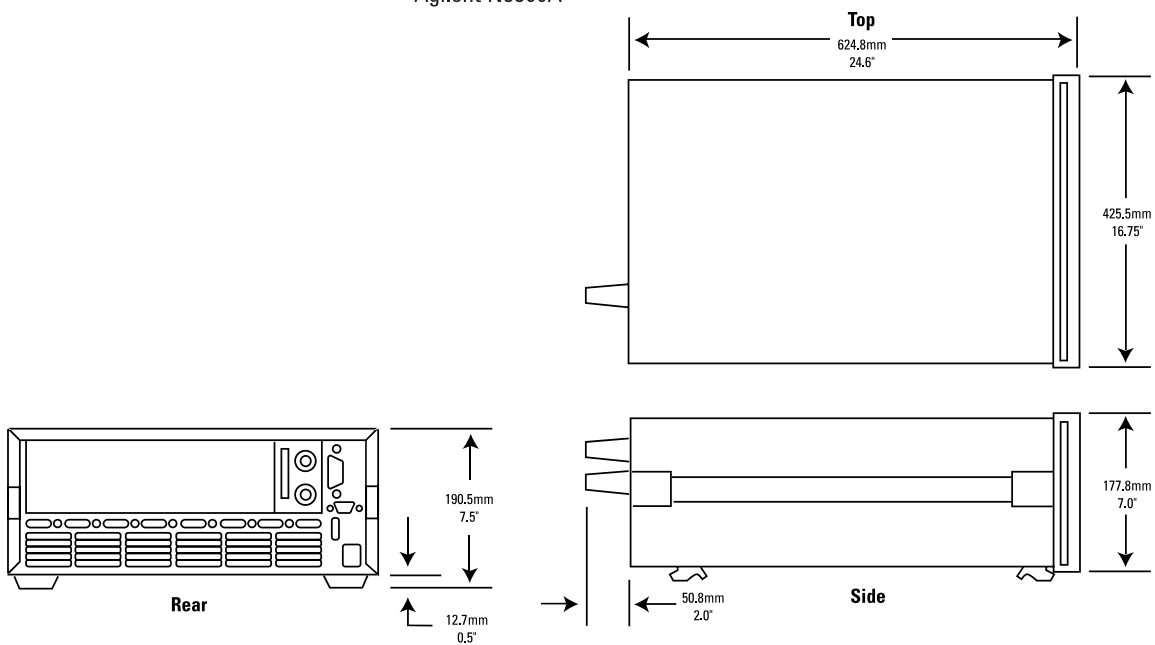

Agilent N3301A

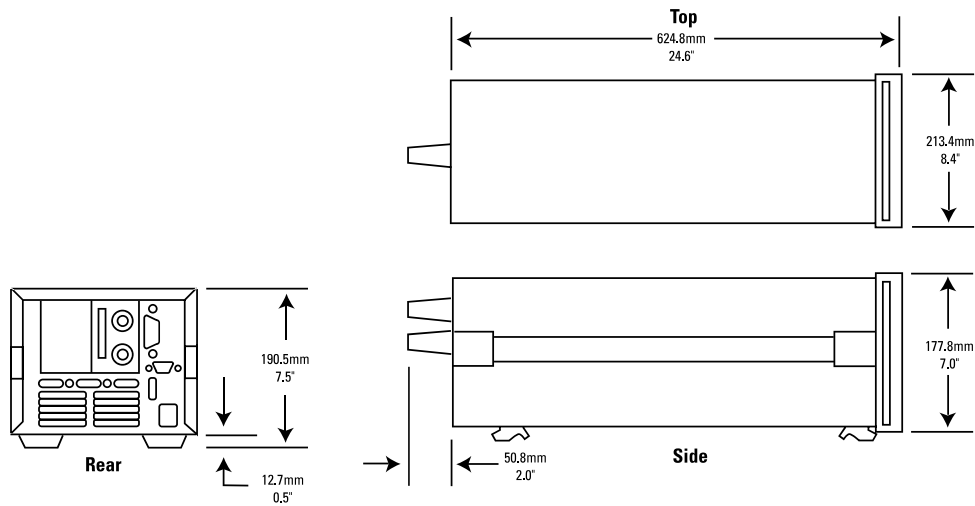

www.agilent.com

Agilent Technologies' Test and Measurement Support, Services, and Assistance

Agilent Technologies aims to maximize the value you receive, while minimizing your risk and problems. We strive to ensure that you get the test and measurement capabilities you paid for and obtain the support you need. Our extensive support resources and services can help you choose the right Agilent products for your applications and apply them successfully. Every instrument and system we sell has a global warranty. Support is available for at least five years beyond the production life of the product. Two concepts underlie Agilent's overall support policy: "Our Promise" and "Your Advantage."

Our Promise

Our Promise means your Agilent test and measurement equipment will meet its advertised performance and functionality. When you are choosing new equipment, we will help you with product information, including realistic performance specifications and practical recommendations from experienced test engineers. When you use Agilent equipment, we can verify that it works properly, help with product operation, and provide basic measurement assistance for the use of specified capabilities, at no extra cost upon request. Many self-help tools are available.

Your Advantage

Your Advantage means that Agilent offers a wide range of additional expert test and measurement services, which you can purchase according to your unique technical and business needs. Solve problems efficiently and gain a competitive edge by contracting with us for calibration, extra-cost upgrades, out-of-warranty repairs, and on-site education and training, as well as design, system integration, project management, and other professional engineering services. Experienced Agilent engineers and technicians worldwide can help you maximize your productivity, optimize the return on investment of your Agilent instruments and systems, and obtain dependable measurement accuracy for the life of those products.



Agilent Email Updates

www.agilent.com/find/emailupdates

Get the latest information on the products and applications you select.

By internet, phone, or fax, get assistance with all your test & measurement needs

Online assistance:
www.agilent.com/find/assist

Phone or Fax

United States:

(tel) 1 800 452 4844

Canada:

(tel) 1 877 894 4414

(fax) (905) 282 6495

China:

(tel) 800 810 0189

(fax) 800 820 2816

Europe:

(tel) (31 20) 547 2323

(fax) (31 20) 547 2390

Japan:

(tel) (81) 426 56 7832

(fax) (81) 426 56 7840

Korea:

(tel) (82 2) 2004 5004

(fax) (82 2) 2004 5115

Latin America:

(tel) (305) 269 7500

(fax) (305) 269 7599

Taiwan:

(tel) 0800 047 866

(fax) 0800 286 331

Other Asia Pacific Countries:

(tel) (65) 6375 8100

(fax) (65) 6386 0252

Email: tm_asia@agilent.com

Product specifications and descriptions in this document subject to change without notice.

© Agilent Technologies, Inc. 2002

Printed in the USA March 28, 2002

5980-0232E



Agilent Technologies