

Series 2600A

- Combines a power supply, true current source, DMM, arbitrary waveform generator, V or I pulse generator with measurement, electronic load, and trigger controller – all in one instrument
- Backward code compatible to Series 2600 System SourceMeter® Instruments for drop-in replacement
- TSP® Express software tool for quick and easy I-V test
- Precision timing and channel synchronization (<500ns)
- Parallel test execution for unmatched throughput
- 20,000 rdg/s provides faster test times and ability to capture transient device behavior
- Family of products offers wide dynamic range: 1fA to 10A and 1µV to 200V
- TSP-Link® bus allows up to 32 units/ 64 channels of channel expansion per GPIB or IP address
- Test Script Processor (TSP®) runs complete test programs (scripts) in the instrument for unparalleled system automation
- USB port for saving data and test scripts
- LXI Class C compliance provides high speed data transfer and enables quick, easy remote testing, monitoring, and troubleshooting

System SourceMeter® Instruments



Series 2600A System SourceMeter instruments are Keithley's latest I-V source-measure instruments for use as either a bench-top I-V characterization tool or as a building block component of multi-channel I-V test systems. For bench-top use, Series 2600A instruments feature an embedded TSP® Express Software Tool that allows users to quickly and easily perform common I-V tests without programming or installing software. For system level applications, Series 2600A's Test Script Processor (TSP®) architecture along with new capabilities such as parallel test execution and precision timing provides the highest throughput in the industry to lower the cost of test.

Series 2600A System SourceMeter instruments replace the popular Series 2600 System SourceMeter instruments with a superset of features. The Series 2600A provides backward code compatibility to the Series 2600, so customers can drop-in replace Series 2600 with Series 2600A.

Quick and Easy Lab or Bench-Top Use

For lab or bench-top use, the Series 2600A SourceMeter instruments offer a complete I-V measurement solution with unmatched ease-of-use, capability, and flexibility to simplify the process of making high-performance measurements and speed time-to-market for the customers.

The user can easily connect the Series 2600A SourceMeter instrument to the PC by using the Ethernet cable (provided with the instrument) and by entering the IP address in the web browser to automatically load the built-in LXI web page. TSP® Express can then be launched from the built-in LXI web page, so neither software installation nor GPIB connection are needed. The TSP Express Software Tool provides an intuitive user interface to quickly setup and run basic and advanced tests including nested step/sweeps, pulse sweeps, and custom sweeps for device characterization applications. For applications where single point I-V source-delay-measure is all that is needed, the tool also provides an interface to quickly configure and measure discrete points. The data can then be viewed in graphical or tabular formats and can be readily exported to a .csv file for use with spreadsheet applications. For more advanced test requirements, the automatic script generation feature simplifies the process of writing custom programs.

CONNECT DUT

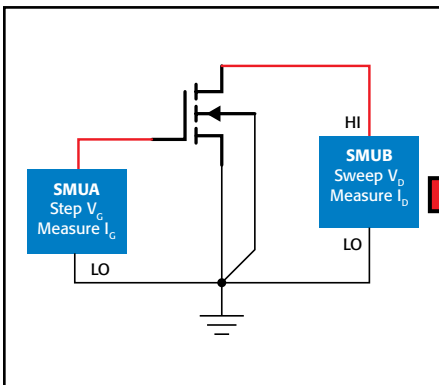

CONFIGURE Test

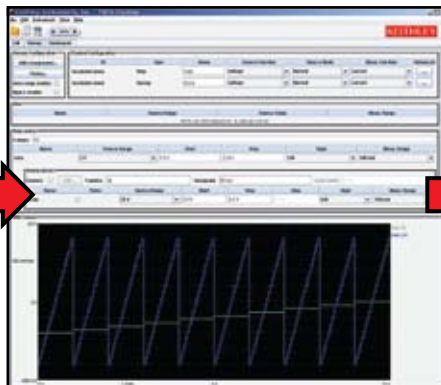

COLLECT Data

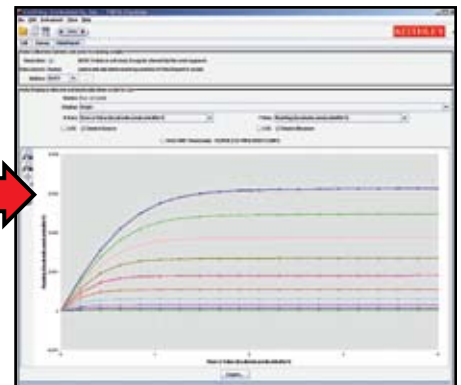

Performing nested sweeps to characterize a transistor with TSP Express is quick and easy. Data can be exported to a .csv file for use with spreadsheet applications such as Excel®.

1.888.KEITHLEY (U.S. only)

www.keithley.com

KEITHLEY

A GREATER MEASURE OF CONFIDENCE

Scalable, integrated source and measure solutions

SOURCE AND MEASURE

Series 2600A

System SourceMeter® Instruments

Unmatched Throughput and Flexibility for High Performance I-V Test Systems

TSP technology provides remarkable capabilities when the Series 2600A is integrated as part of a multi-channel I-V test system.

First, the embedded scripting capability allows for complete test scripts to be run by the instrument. Test scripts are complete test programs based on an easy to use but highly efficient and compact scripting language called 'Lua' <www.lua.org>. Since the test scripts can contain any sequence of routines that can be executed by conventional programming languages (including decision making algorithms), this feature allows entire tests to be managed by the instrument without sending readings back to the PC for decision making. This means that delays due to GPIB traffic congestion are eliminated, and overall test times are greatly improved.

Second, TSP technology offers "mainframe-less channel expansion." The TSP-Link® channel expansion bus (which uses a 100 Base T Ethernet cable) allows multiple Series 2600A instruments (and other TSP instruments) to be connected in a master-slave configuration and behave as one integrated system. TSP-Link supports up to 32 units or 64 SMU channels per GPIB or IP address. This provides virtually unlimited channel count, allowing a system to be scaled to fit the particular requirements of an application.

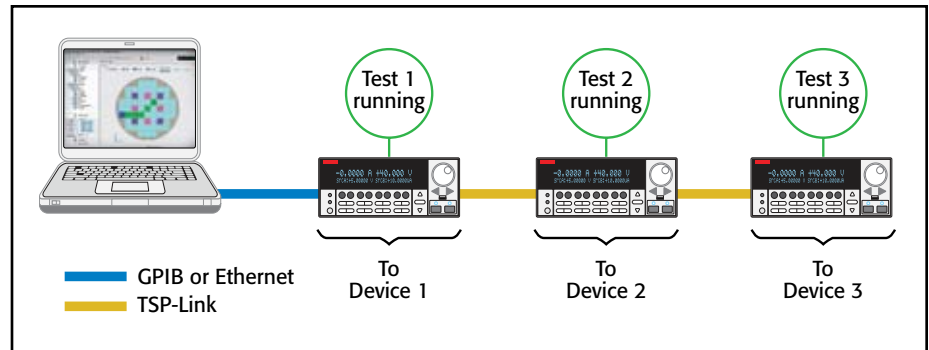

Parallel testing with the Series 2600A

Parallel Test Capability

As the next evolutionary step in TSP technology, the Series 2600A takes system level performance to a new height with parallel testing capability. This feature allows customers to test multiple devices in parallel to meet the high throughput requirements of production test and advanced semiconductor lab applications.

Parallel test capability enables each instrument in the system to have the ability to run its own complete test sequence. Hence, the number of tests that can be running in parallel on a Series 2600A system can be as many as the number of instruments in the system. In contrast, most conventional test systems run a single thread of the test usually on the controller PC instead of the instrument itself.

This parallel test capability allows Series 2600A systems to behave as a fully multi-threaded test environment. Testing multiple devices at the same time means dramatically improved test throughput and reduced overall cost of test.

Additionally the Series 2600A system can be reconfigured via software, without rewiring, to match different devices with different pin-layouts to appropriate SMU-per-pin configurations.

Tight Timing and Synchronization

Today's test engineers are challenged with testing increasingly more complex and more sensitive devices that require precision timing and synchronization among all test instruments involved. Whether the test is to synchronize electrical and optical tests of an optoelectronic component or to ensure that the same stress times are applied to the different pins of an advanced semiconductor device, providing precision timing and synchronization between SMU channels (and external instruments) has become a critical requirement.

A high performance hardware driven trigger model allows timing at each I-V source-measure step to be controlled precisely and operations between SMU channels and/or external instrumentation to be synchronized at hardware speeds (<500ns).

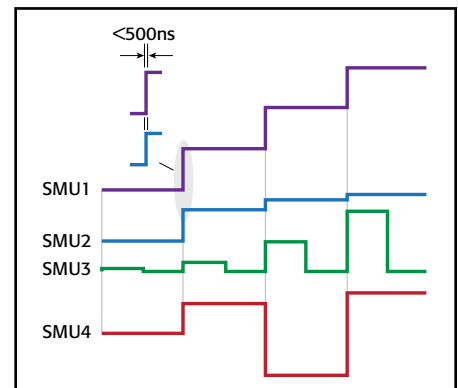

All channels in the system are synchronized to under 500ns.

1.888.KEITHLEY (U.S. only)

www.keithley.com

KEITHLEY

Series 2600A

System SourceMeter® Instruments

Third-generation SMU design ensures faster test times

Based on the proven architecture of earlier Series 2600 instruments, the Series 2600A's new SMU design enhances test speed in several ways. For example, while earlier designs used a parallel current ranging topology, the Series 2600A uses a patented series ranging topology, which provides faster and smoother range changes and outputs that settle more quickly. The new Series 2600A SMU design supports two modes of operations for use with a variety of loads. In normal mode, the Series 2600A SMU provides high bandwidth performance for maximum throughput, while in high-capacitive (high-C) mode, the SMU uses a slower bandwidth in order to provide robust performance with higher capacitive loads.

Each Series 2600A's SMU channel offers a highly flexible, four-quadrant source coupled with precision voltage and current meters.

Each channel can be configured as a:

- Precision power supply
- True current source
- DMM (DCV, DCI, ohms, power, with 5½-digit resolution)
- Electronic load (with sink mode capability)
- V or I pulse generator (Pulse width: 100µs and longer)
- V or I waveform generator

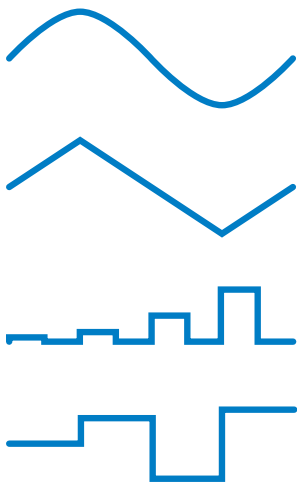

Current arbitrary waveforms maximum output update rates: 12,500 samples/second.

Voltage arbitrary waveforms maximum output update rates: 20,000 samples/second.

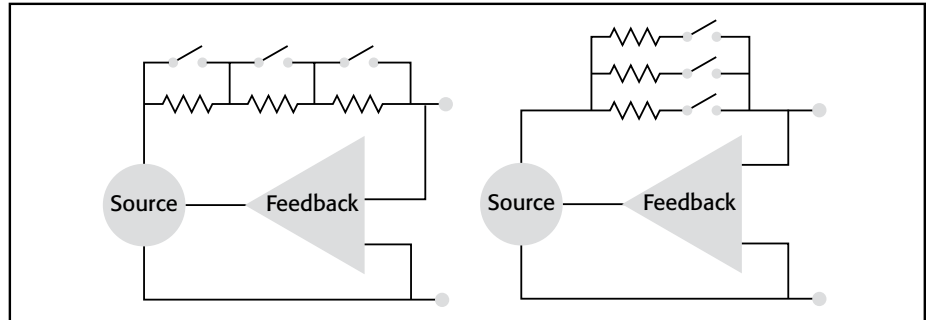

Series vs. parallel ranging topologies

All A/D converters in the Series 2600A instruments are both high speed and high precision for maximum flexibility.

All Series 2600A instruments provide four-quadrant operation and can be connected in series or in parallel to extend their dynamic range. They measure voltage and current simultaneously with up to 5½-digit resolution, and they display voltage, current, resistance, or power readings. Two analog-to-digital converters per channel (one for I, one for V) can run simultaneously, providing precise source-readback without sacrificing test throughput. These A/D converters offer the flexibility of programmable integration rates, allowing the user to optimize for either high speed (>20,000 rdgs/s at 0.001 NPLC setting) or for high resolution (up to 24 bits at 10 NPLC setting) measurements.

Digital I/O Interface

A back panel port on every Series 2600A instrument provides 14 bits of universal digital I/O to link the instrument to a variety of popular component handlers and/or probe stations. These I/O lines are also backward-compatible with Keithley's earlier Trigger-Link instrument triggering technology. These lines simplify integrating Series 2600A instruments into systems that employ other electrical, mechanical, optical, or RF equipment.

TSP-Link® Trigger Lines

The TSP-Link bus supports the dedicated trigger lines. This means synchronous operations between multiple Series 2600A and other TSP instruments, such as Series 3700 DMM/Switch Systems, that are connected via TSP-Link bus can be achieved without the need for additional trigger connections.

TYPICAL APPLICATIONS

I-V functional test and characterization of a wide range of devices, including:

- Discrete and passive components

- Two-leaded – Sensors, disk drive heads, metal oxide varistors (MOVs), diodes, zener diodes, sensors, capacitors, thermistors
- Three-leaded – Small signal bipolar junction transistors (BJTs), field-effect transistors (FETs), and more

- Simple ICs – Optos, drivers, switches, sensors

- Integrated devices – Small Scale Integrated (SSI) and Large Scale Integrated (LSI).

- Analog ICs
- Radio frequency integrated circuits (RFICs)
- Application specific integrated circuits (ASICs)
- System on a chip (SOC) devices

- Optoelectronic devices such as light-emitting diodes (LEDs), laser diodes, high brightness LEDs (HBLEDs), vertical cavity surface-emitting lasers (VCSELs), displays

- Wafer level reliability –NBTI, TDDb, HCI, Electromigration

- Solar Cells
- Batteries

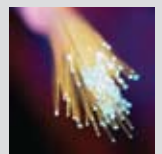

Scalable, integrated source and measure solutions

SOURCE AND MEASURE

1.888.KEITHLEY (U.S. only)

www.keithley.com

KEITHLEY

A GREATER MEASURE OF CONFIDENCE

Series 2600A

System SourceMeter® Instruments

Ordering Information

2601A	Single-channel System SourceMeter® Instrument (3A DC, 10A Pulse)
2602A	Dual-channel System SourceMeter® Instrument (3A DC, 10A Pulse)
2611A	Single-channel System SourceMeter® Instrument (200V, 10A Pulse)
2612A	Dual-channel System SourceMeter® Instrument (200V, 10A Pulse)
2635A	Single-channel System SourceMeter® Instrument (1fA, 10A Pulse)
2636A	Dual-channel System SourceMeter® Instrument (1fA, 10A Pulse)

Accessories Supplied

2600-ALG-2	Low Noise Triax Cable with Alligator Clips, 2m (6.6 ft.) (two supplied with 2636A, one with 2635A)
2600-IAC	Safety Interlock Adapter Connector (one supplied with 2611A/2612A and 2635A/2636A)
2600-Kit	Mating screw terminal connectors with strain relief and covers (2601A/2602A/2611A/2612A)
CA-180-3A	TSP-Link/Ethernet Cable (two per unit)
	TSP® Express Software Tool (embedded)
	Test Script Builder Software
	LabTracer II Software (downloadable)

Built-in Contact Check Function

The Contact Check function makes it simple to verify good device-under-test connections quickly and easily before an automated test sequence begins. This eliminates measurement errors and false product failures associated with contact fatigue, breakage, contamination, loose or broken connection, relay failures, etc.

Powerful Software Tools Are Standard

The Series 2600A includes three powerful software tools to make programming and use easier. In addition to TSP® Express there is LabTracer 2 for basic characterization over GPIB bus and Test Script Builder for writing custom scripts.

Test Script Builder is a free software tool that is provided with all Series 2600A SourceMeter instruments to help users create, modify, debug, and store TSP test scripts. It provides a project/file manager window to store and organize test scripts, a text-sensitive program editor (like Visual Basic) to create and modify test TSP code, and an immediate instrument control window to send GPIB commands and receive data from the instrument. The immediate window allows viewing the output of a given test script and simplifies debugging.

The table below describes key features of Series 2600A software tools.

Complete System Solutions

For customers who prefer complete system solutions, Keithley offers Automated Characterization Suite (ACS) Integrated Test Systems. ACS systems are highly configurable, instrument-based systems for semiconductor device characterization, reliability/WLR, parametric, and component functional testing. ACS systems can be configured with a variety of automation options from wafer or cassette automation to integration with component handlers. ACS systems come with extensive libraries for component tests and device characterization. Data is available in a wide range of output formats including easy data export customization. With ACS systems, customers can readily access the advanced features of Series 2600A instruments with interactive project setup without code writing.



Feature/Functionality	LabTracer II (LT2)	TSP® Express	TestScript Builder (TSB)
Description	Software Tool for Basic Device Characterization.	Embedded Software Tool for quick and easy I-V testing, primarily for bench and lab users.	Primary script writing tool for TSP instruments.
Supported HW	24xx, 6430, 26xx & 26xxA	26xxA	26xx, 26xxA, 37xx
Supported buses	GPIB, RS-232	Ethernet only	GPIB, RS-232, Ethernet
Functionality	Sweeps & Pulse Sweeps	Linear/Log Sweeps, Pulsing, Custom sweeps, single point source-measures. Note: Uses new 2600A's new APIs for precision timing & channel synchronization	Custom scripts with total flexibility
Data management	Basic curve tracing contains basic math formulator	.csv export, basic curve tracing (no math formula or analysis support)	N/A
Installation	Free Download. Install on PC.	Not necessary. Embedded in the instrument.	Free Download or CD Install on PC.

1.888.KEITHLEY (U.S. only)

www.keithley.com

KEITHLEY

A GREATER MEASURE OF CONFIDENCE

Series 2600A

System SourceMeter® Instruments

In the first and third quadrants, Series 2600A instruments operate as a source, delivering power to a load. In the second and fourth quadrants, they operate as a sink, dissipating power internally.

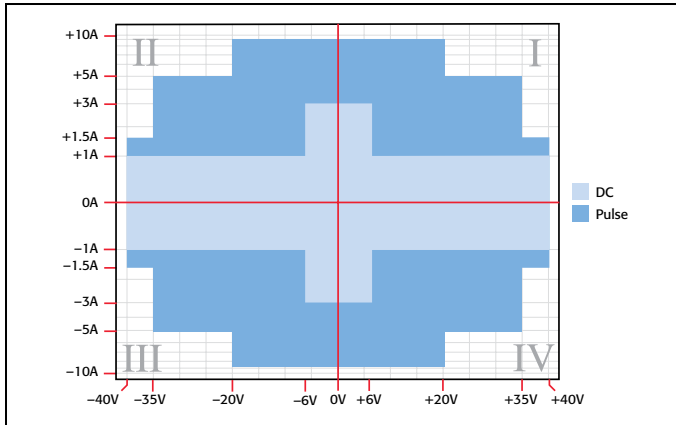

Models 2601A and 2602A I-V capability

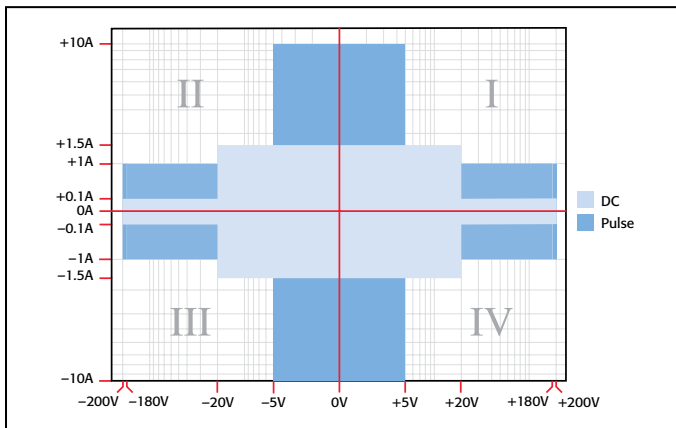

Models 2611A and 2612A I-V capability

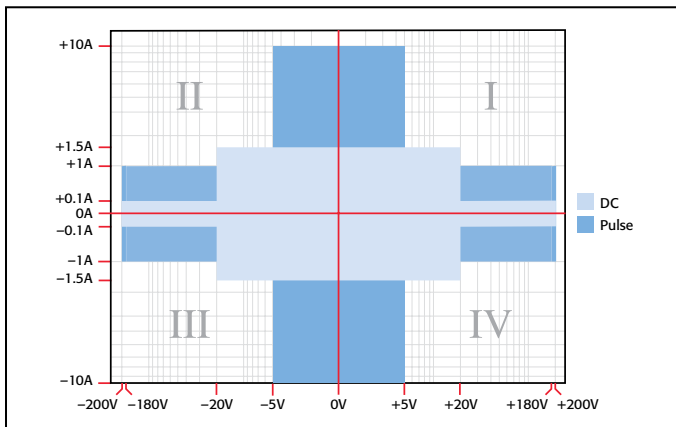

Models 2635A and 2636A I-V capability

ACCESSORIES AVAILABLE

CABLES AND CONNECTORS

2600-BAN	Banana Test Leads/Adapter Cable. For a single 2601A/2602A/2611A/2612A SMU channel
2600-KIT	Extra screw terminal connector, strain relief, and cover for a single SourceMeter channel (one supplied with 2601A/2611A, two with 2602A/2612A)
2600-TRIAX	Triax Adapter. For a single 2601A/2602A/2611A/2612A SMU channel
7078-TRX-*	3-Slot, Low Noise Triax Cable. For use with 2600-TRIAX Adapter
7078-TRX-GND	3-Slot male triax to BNC adapter (guard removed)
8606	High Performance Modular Probe Kit. For use with 2600-BAN
SC-200	Shielded Twisted Pair Cable. Recommended for general-purpose use with Series 2600A System SourceMeter® instruments
2600-IAC	Safety Interlock Adapter Connector (one supplied with 2611A/2612A/2635A/2636A)

DIGITAL I/O, TRIGGER LINK, AND TSP-LINK

2600-TLINK	Digital I/O to TLINK Adapter Cable, 1m
CA-126-1	Digital I/O and Trigger Cable, 1.5m
CA-180-3A	CAT5 Crossover Cable for TSP-Link and direct Ethernet connection (two supplied)

GPIB INTERFACES AND CABLES

7007-1	Double Shielded GPIB Cable, 1m (3.3 ft)
7007-2	Double Shielded GPIB Cable, 2m (6.6 ft)
KPCI-488LP	IEEE-488 Interface/Controller for the PCI Bus
KPXI-488	IEEE-488 Interface Board for the PXI Bus
KUSB-488A	IEEE-488 USB-to-GPIB Interface Adapter

SWITCHING

Series 3700	DMM/Switch Systems
707A	Semiconductor Switching Matrix Mainframe
7001	Switch Control Mainframe
7002-HD	High Density Switch Mainframe

RACK MOUNT KITS

4299-1	Single Rack Mount Kit with front and rear support
4299-2	Dual Rack Mount Kit with front and rear support
4299-5	IU Vent Panel

EXTENDED WARRANTIES

2601A-EW	1 Year Extended Warranty for Model 2601A
2602A-EW	1 Year Extended Warranty for Model 2602A
2611A-EW	1 Year Extended Warranty for Model 2611A
2612A-EW	1 Year Extended Warranty for Model 2612A
2635A-EW	1 Year Extended Warranty for Model 2635A
2636A-EW	1 Year Extended Warranty for Model 2636A

CALIBRATION AND VERIFICATION

2600-STD-RES	Calibration Standard 1GΩ Resistor for Models 2635A and 2636A
--------------	--

Model 2602A/2612A rear panel
(Single channels 2601A, 2611A, 2635A not shown)



Model 2636A rear panel



Scalable, integrated source and measure solutions

SOURCE AND MEASURE

1.888.KEITHLEY (U.S. only)

www.keithley.com

KEITHLEY

A GREATER MEASURE OF CONFIDENCE

2601A 2602A

System SourceMeter® Instruments

Series 2600A specifications

SOURCE AND MEASURE

SPECIFICATION CONDITIONS

This document contains specifications and supplemental information for the Models 2601A and 2602A. Specifications are the standards against which the Models 2601A and 2602A are tested. Upon leaving the factory, the 2601A and 2602A meet these specifications. Supplemental and typical values are non-warranted, apply at 23°C, and are provided solely as useful information.

Accuracy specifications are applicable for both normal and high capacitance modes. The source and measurement accuracies are specified at the SourceMeter CHANNEL A (2601A and 2602A) or SourceMeter CHANNEL B (2602A) terminals under the following conditions:

1. 23°C ± 5°C, <70% relative humidity.
2. After 2 hour warm-up.
3. Speed normal (1 NPLC).
4. A/D auto-zero enabled.
5. Remote sense operation or properly zeroed local operation.
6. Calibration period = 1 year.

SOURCE SPECIFICATIONS

VOLTAGE SOURCE SPECIFICATIONS

VOLTAGE PROGRAMMING ACCURACY¹

Range	Programming Resolution	Accuracy (1 Year) 23°C ± 5°C ±(% rdg. + volts)	Typical Noise (peak-peak) 0.1Hz–10Hz
100.000 mV	5 μV	0.02% + 250 μV	20 μV
1.00000 V	50 μV	0.02% + 400 μV	50 μV
6.00000 V	50 μV	0.02% + 1.8 mV	100 μV
40.0000 V	500 μV	0.02% + 12 mV	500 μV

TEMPERATURE COEFFICIENT (0°–18°C & 28°–50°C): ±(0.15 × accuracy specification)/°C. Applicable for normal mode only. Not applicable for high capacitance mode.

MAXIMUM OUTPUT POWER AND SOURCE/SINK LIMITS²: 40.4W per channel maximum. ±40.4V @ ±1.0A, ±6.06V @ ±3.0A, four quadrant source or sink operation.

VOLTAGE REGULATION: Line: 0.01% of range. Load: ±(0.01% of range + 100μV).

NOISE 10Hz–20MHz: <20mV peak-peak (typical), <3mV RMS (typical), 6V range.

CURRENT LIMIT/COMPLIANCE³: Bipolar current limit (compliance) set with single value. Minimum value is 10nA. Accuracy same as current source.

OVERSHOOT: <±(0.1% + 10mV) typical. Step size = 10% to 90% of range, resistive load, maximum current limit/compliance.

GUARD OFFSET VOLTAGE: <4mV typical. Current <10mA.

CURRENT SOURCE SPECIFICATIONS

CURRENT PROGRAMMING ACCURACY

Range	Programming Resolution	Accuracy (1 Year) 23°C ± 5°C ±(% rdg. + amps)	Typical Noise (peak-peak) 0.1Hz–10Hz
100.000 nA	1 pA	0.06% + 100 pA	5 pA
1.00000 μA	10 pA	0.03% + 800 pA	25 pA
10.0000 μA	100 pA	0.03% + 5 nA	60 pA
100.000 μA	1 nA	0.03% + 60 nA	3 nA
1.00000 mA	10 nA	0.03% + 300 nA	6 nA
10.0000 mA	100 nA	0.03% + 6 μA	200 nA
100.000 mA	1 μA	0.03% + 30 μA	600 nA
1.00000 A ⁴	10 μA	0.05% + 1.8 mA	70 μA
3.00000 A ⁴	10 μA	0.06% + 4 mA	150 μA
10.0000 A ^{4,5}	100 μA	0.5% + 40 mA (typical)	

TEMPERATURE COEFFICIENT (0°–18°C & 28°–50°C): ±(0.15 × accuracy specification)/°C.

MAXIMUM OUTPUT POWER AND SOURCE/SINK LIMITS²: 40.4W per channel maximum. ±1.01A @ ±40.0V, ±3.03A @ ±6.0V, four quadrant source or sink operation.

CURRENT REGULATION: Line: 0.01% of range. Load: ±(0.01% of range + 100pA).

VOLTAGE LIMIT/COMPLIANCE⁶: Bipolar voltage limit (compliance) set with a single value. Minimum value is 10mV. Accuracy is the same as voltage source.

OVERSHOOT: <±0.1% typical (step size = 10% to 90% of range, resistive load; see CURRENT SOURCE OUTPUT SETTLING TIME for additional test conditions).

ADDITIONAL SOURCE SPECIFICATIONS

TRANSIENT RESPONSE TIME: <70μs for the output to recover to 0.1% for a 10% to 90% step change in load.

VOLTAGE SOURCE OUTPUT SETTLING TIME: Time required to reach 0.1% of final value after source level command is processed on a fixed range.

100mV, 1V Ranges: <50μs typical.

6V Range: <100μs typical.

40V Range: <150μs typical.⁷

CURRENT SOURCE OUTPUT SETTLING TIME: Time required to reach 0.1% of final value after source level command is processed on a fixed range. Values below for Iout × Rload = 2V unless noted.

3A Range: <80μs typical (current less than 2.5A, Rload >2Ω).

1A–10mA Ranges: <80μs typical (Rload >6Ω).

1mA Range: <100μs typical.

100μA Range: <150μs typical.

10μA Range: <500μs typical.

1μA Range: <2.5ms typical.

100nA Range: <25ms typical.

DC FLOATING VOLTAGE: Output can be floated up to ±250VDC from chassis ground.

REMOTE SENSE OPERATING RANGE⁸:

Maximum voltage between HI and SENSE HI = 3V.

Maximum voltage between LO and SENSE LO = 3V.

VOLTAGE OUTPUT HEADROOM:

40V Range: Max. output voltage = 42V – total voltage drop across source leads (maximum 1Ω per source lead).

6V Range: Max. output voltage = 8V – total voltage drop across source leads (maximum 1Ω per source lead).

OVER TEMPERATURE PROTECTION: Internally sensed temperature overload puts unit in standby mode.

VOLTAGE SOURCE RANGE CHANGE OVERSHOOT: <300mV + 0.1% of larger range (typical). Overshoot into a 100kΩ load, 20MHz BW.

CURRENT SOURCE RANGE CHANGE OVERSHOOT: <5% of larger range + 300mV/Rload (typical with source settling set to SETTLE_SMOOTH_100NA). See CURRENT SOURCE OUTPUT SETTLING TIME for additional test conditions.

NOTES

1. Add 50μV to source accuracy specifications per volt of HI lead drop.
2. Full power source operation regardless of load to 30°C ambient. Above 30°C and/or power sink operation, refer to "Operating Boundaries" in the Series 2600A Reference Manual for additional power derating information.
3. For sink mode operation (quadrants II and IV), add 0.06% of limit range to the corresponding current limit accuracy specifications. Specifications apply with sink mode operation enabled.
4. Full power source operation regardless of load to 30°C ambient. Above 30°C and/or power sink operation, refer to "Operating Boundaries" in the Series 2600A Reference Manual for additional power derating information.
5. 10A range accessible only in pulse mode.
6. For sink mode operation (quadrants II and IV), add 10% of compliance range and ±0.02% of limit setting to corresponding voltage source specification. For 100mV range add an additional 60mV of uncertainty.
7. Add 150μs when measuring on the 1A range.
8. Add 50μV to source accuracy specifications per volt of HI lead drop.

1.888.KEITHLEY (U.S. only)

www.keithley.com

KEITHLEY

A GREATER MEASURE OF CONFIDENCE

2601A 2602A

System SourceMeter® Instruments

SOURCE SPECIFICATIONS (continued)

PULSE SPECIFICATIONS

Region	Maximum Current Limit	Maximum Pulse Width ⁹	Maximum Duty Cycle ⁹
1	1 A @ 40 V	DC, no limit	100%
1	3 A @ 6 V	DC, no limit	100%
2	1.5 A @ 40 V	100 ms	25%
3	5 A @ 35 V	4 ms	4%
4	10 A @ 20 V	1.8 ms	1%

MINIMUM PROGRAMMABLE PULSE WIDTH^{9, 11}: 100 μ s. NOTE: Minimum pulse width for settled source at a given I/V output and load can be longer than 100 μ s.

PULSE WIDTH PROGRAMMING RESOLUTION: 1 μ s.

PULSE WIDTH PROGRAMMING ACCURACY⁹: $\pm 5\mu$ s.

PULSE WIDTH JITTER: 2 μ s (typical).

QUADRANT DIAGRAM:

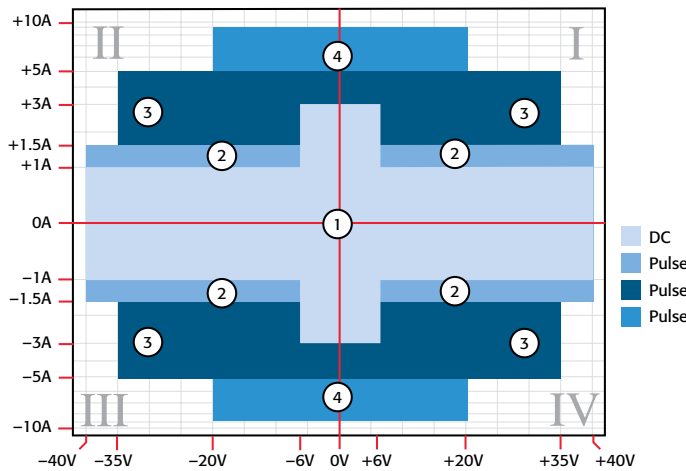

NOTES

9. Times measured from the start of pulse to the start off-time; see figure below.

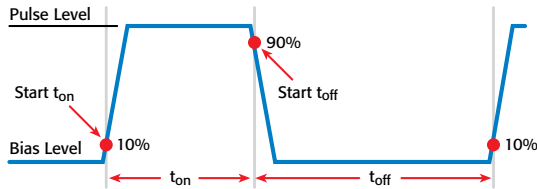

10. Thermally limited in sink mode (quadrants II and IV) and ambient temperatures above 30°C. See power equations in the reference manual for more information.

11. Typical performance for minimum settled pulse widths:

Source Value	Load	Source Settling (% of range)	Min. Pulse Width
6 V	2 Ω	0.2%	150 μ s
20 V	2 Ω	1%	200 μ s
35 V	7 Ω	0.5%	500 μ s
40 V	27 Ω	0.1%	400 μ s
1.5 A	27 Ω	0.1%	1.5 ms
3 A	2 Ω	0.2%	150 μ s
5 A	7 Ω	0.5%	500 μ s
10 A	2 Ω	0.5%	200 μ s

Typical tests were performed using remote operation, 4W sense, Keithley 2600-BAN cables and best, fixed measurement range. For more information on pulse scripts, see the Series 2600 Reference Manual.

METER SPECIFICATIONS

VOLTAGE MEASUREMENT ACCURACY^{13, 14}

Range	Display Resolution ¹⁵	Input Resistance	Accuracy (1 Year) 23°C \pm 5°C \pm (% rdg. + volts)
100.000 mV	1 μ V	>10 G Ω	0.015% + 150 μ V
1.00000 V	10 μ V	>10 G Ω	0.015% + 200 μ V
6.00000 V	10 μ V	>10 G Ω	0.015% + 1 mV
40.0000 V	100 μ V	>10 G Ω	0.015% + 8 mV

TEMPERATURE COEFFICIENT (0°–18°C & 28°–50°C): $\pm(0.15 \times$ accuracy specification)/°C. Applicable for normal mode only. Not applicable for high capacitance mode.

CURRENT MEASUREMENT ACCURACY

Range	Display Resolution ¹⁵	VOLTAGE BURDEN ¹⁶	Accuracy (1 Year) 23°C \pm 5°C \pm (% rdg. + amps)
100.000 nA	1 pA	<1 mV	0.05% + 100 pA
1.00000 μ A	10 pA	<1 mV	0.025% + 500 pA
10.0000 μ A	100 pA	<1 mV	0.025% + 1.5 nA
100.000 μ A	1 nA	<1 mV	0.02% + 25 nA
1.00000 mA	10 nA	<1 mV	0.02% + 200 nA
10.0000 mA	100 nA	<1 mV	0.02% + 2.5 μ A
100.000 mA	1 μ A	<1 mV	0.02% + 20 μ A
1.00000 A	10 μ A	<1 mV	0.03% + 1.5 mA
3.00000 A	10 μ A	<1 mV	0.05% + 3.5 mA
10.0000 A ¹⁷	100 μ A	<1 mV	0.4% + 25 mA (typical)

CURRENT MEASURE SETTLING TIME (Time for measurement to settle after a Vstep)¹⁸: Time required to reach 0.1% of final value after source level command is processed on a fixed range. Values for Vout = 1V unless noted. Current Range: 1mA. Settling Time: <10 μ s (typical).

TEMPERATURE COEFFICIENT (0°–18°C & 28°–50°C): $\pm(0.15 \times$ accuracy specification)/°C. Applicable for normal mode only. Not applicable for high capacitance mode.

CONTACT CHECK¹⁹

Speed	Maximum Measurement Time To Memory For 60Hz (50Hz)	Accuracy (1 Year) 23°C \pm 5°C \pm (%rdg. + ohms)
FAST	1 (1.2) ms	5% + 10 Ω
MEDIUM	4 (5) ms	5% + 1 Ω
SLOW	36 (42) ms	5% + 0.3 Ω

ADDITIONAL METER SPECIFICATIONS

MAXIMUM LOAD IMPEDANCE:

Normal Mode: 10nF (typical). High Capacitance Mode: 50 μ F (typical).

COMMON MODE VOLTAGE: 250VDC.

COMMON MODE ISOLATION: >1G Ω , <4500pF.

OVERRRANGE: 101% of source range, 102% of measure range.

MAXIMUM SENSE LEAD RESISTANCE: 1k Ω for rated accuracy.

SENSE INPUT IMPEDANCE: >10G Ω .

NOTES

13. Add 50 μ V to source accuracy specifications per volt of HI lead drop.

14. De-rate accuracy specifications for NPLC setting < 1 by increasing error term.

Add appropriate % of range term using table below.

NPLC Setting	100mV Range	1V–40V Ranges	100nA Range	1 μ A–100mA Ranges	1A–3A Ranges
0.1	0.01%	0.01%	0.01%	0.01%	0.01%
0.01	0.08%	0.07%	0.1%	0.05%	0.05%
0.001	0.8 %	0.6 %	1%	0.5 %	1.1 %

15. Applies when in single channel display mode.

16. Four-wire remote sense only with current meter mode selected. Voltage measure set to 100mV or 1V range only.

17. 10A range accessible only in pulse mode.

18. Compliance equal to 100mA.

19. Includes measurement of SENSE HI to HI and SENSE LO to LO contact resistances.

Series 2600A specifications

SOURCE AND MEASURE

1.888.KEITHLEY (U.S. only)

www.keithley.com

KEITHLEY

A GREATER MEASURE OF CONFIDENCE

2601A 2602A

System SourceMeter® Instruments

HIGH CAPACITANCE MODE²⁰

VOLTAGE SOURCE OUTPUT SETTLING TIME: Time required to reach 0.1% of final value after source level command is processed on a fixed range. Current limit = 1A.

Voltage Source Range	Settling Time with Load = 4.7μF
100 mV	200 μs (typical)
1 V	200 μs (typical)
6 V	200 μs (typical)
40 V	7 ms (typical)

CURRENT MEASURE SETTLING TIME: Time required to reach 0.1% of final value after voltage source is stabilized on a fixed range. Values below for Vout = 1V unless noted.

Current Measure Range	Settling Time
3 A – 1 A	<120 μs (typical) (Rload > 2Ω)
100 mA – 10 mA	<100 μs (typical)
1 mA	< 3 ms (typical)
100 μA	< 3 ms (typical)
10 μA	< 230 ms (typical)
1 μA	< 230 ms (typical)

CAPACITOR LEAKAGE PERFORMANCE USING HIGH-C SCRIPTS²¹: Load = 5μF || 10MΩ. Test: 5V step and measure. 200ms (typical) @ 50nA.

MODE CHANGE DELAY: 500ms. Voltage Source with High Capacitance Mode ON to Voltage Source with High Capacitance Mode OFF. Voltage Source with High Capacitance Mode ON to Current Source with High Capacitance Mode OFF.

VOLTMETER INPUT IMPEDANCE: 30GΩ in parallel with 3300pF.

VOLTAGE SOURCE RANGE CHANGE OVERSHOOT: <400mV + 0.1% of larger range (typical). Overshoot into a 100kΩ load, 20MHz BW.

NOTES

20. 100nA range is not available in high capacitance mode.
21. Part of KI Factory scripts. See reference manual for details.

SEE PAGES 15 AND 16 FOR MEASUREMENT SPEEDS AND OTHER SPECIFICATIONS.

GENERAL

IEEE-488: IEEE-488.1 compliant. Supports IEEE-488.2 common commands and status model topology.

RS-232: Baud rates from 300bps to 115200bps. Programmable number of data bits, parity type, and flow control (RTS/CTS hardware or none). When not programmed as the active host interface, the SourceMeter instrument can use the RS-232 interface to control other instrumentation.

ETHERNET: RJ-45 connector, LXI Class C, 10/100BT, no auto MDIX.

EXPANSION INTERFACE: The TSP-Link expansion interface allows TSP enabled instruments to trigger and communicate with each other.

Cable Type: Category 5e or higher LAN crossover cable.

Length: 3 meters maximum between each TSP enabled instrument.

LXI COMPLIANCE: LXI Class C 1.2.

LXI TIMING: Total Output Trigger Response Time: 245μs min., 280μs typ., (not specified) max. **Receive LAN[0-7] Event Delay:** Unknown. **Generate LAN[0-7] Event Delay:** Unknown.

DIGITAL I/O INTERFACE:

Connector: 25-pin female D.

Input/Output Pins: 14 open drain I/O bits.

Absolute Maximum Input Voltage: 5.25V.

Absolute Minimum Input Voltage: -0.25V.

Maximum Logic Low Input Voltage: 0.7V, +850μA max.

Minimum Logic High Input Voltage: 2.1V, +570μA.

Maximum Source Current (flowing out of Digital I/O bit): +960μA.

Maximum Sink Current @ Maximum Logic Low Voltage (0.7V): -5.0mA.

Absolute Maximum Sink Current (flowing into Digital I/O pin): -11mA.

5V Power Supply Pin: Limited to 600mA, solid state fuse protected.

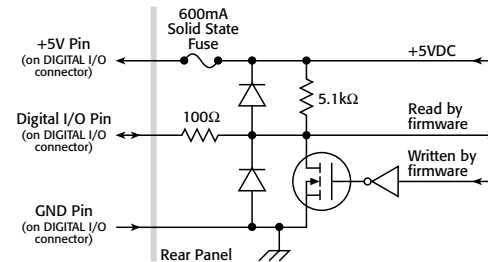

Output Enable Pin: Active high input pulled down internally to ground with 10kΩ resistor. When the Output Enable input function has been activated, each SourceMeter channel will not turn on unless the Output Enable pin is driven to >2.1V (nominal current = 2.1V/10kΩ = 210μA).

USB: USB 1.0 Host Controller (Memory Stick I/O).

POWER SUPPLY: 100V to 250VAC, 50–60Hz (auto sensing), 240VA max.

COOLING: Forced air. Side intake and rear exhaust. One side must be unobstructed when rack mounted.

EMC: Conforms to European Union Directive 2004/108/EEC, EN 61326-1.

SAFETY: Conforms to European Union Directive 73/23/EEC, EN 61010-1, and UL 61010-1.

DIMENSIONS: 89mm high × 213mm wide × 460mm deep (3½ in × 8½ in × 17½ in). Bench Configuration (with handle & feet): 104mm high × 238mm wide × 460mm deep (4¼ in × 9½ in × 17½ in).

WEIGHT: 2601A: 4.75kg (10.4 lbs). 2602A: 5.50kg (12.0 lbs).

ENVIRONMENT: For indoor use only.

Altitude: Maximum 2000 meters above sea level.

Operating: 0°–50°C, 70% R.H. up to 35°C. Derate 3% R.H./°C, 35°–50°C.

Storage: -25°C to 65°C.

1.888.KEITHLEY (U.S. only)

www.keithley.com

KEITHLEY

2611A 2612A

System SourceMeter® Instruments

SPECIFICATION CONDITIONS

This document contains specifications and supplemental information for the Models 2611A and 2612A. Specifications are the standards against which the Models 2611A and 2612A are tested. Upon leaving the factory the 2611A and 2612A meet these specifications. Supplemental and typical values are non-warranted, apply at 23°C, and are provided solely as useful information.

Accuracy specifications are applicable for both normal and high capacitance modes.

The source and measurement accuracies are specified at the SourceMeter CHANNEL A (2611A and 2612A) or SourceMeter CHANNEL B (2612A) terminals under the following conditions:

- 23°C ± 5°C, <70% relative humidity.
- After 2 hour warm-up.
- Speed normal (1 NPLC).
- A/D auto-zero enabled.
- Remote sense operation or properly zeroed local sense operation.
- Calibration period = 1 year.

SOURCE SPECIFICATIONS

VOLTAGE SOURCE SPECIFICATIONS

VOLTAGE PROGRAMMING ACCURACY¹

Range	Programming Resolution	Accuracy (1 Year) 23°C ± 5°C ±(% rdg. + volts)	Noise (Peak-Peak) 0.1Hz–10Hz
200.000 mV	5 μV	0.02% + 375 μV	20 μV
2.00000 V	50 μV	0.02% + 600 μV	50 μV
20.0000 V	500 μV	0.02% + 5 mV	300 μV
200.000 V	5 mV	0.02% + 50 mV	2 mV

TEMPERATURE COEFFICIENT (0°–18°C & 28°–50°C): ±(0.15 × accuracy specification)°C. Applicable for normal mode only. Not applicable for high capacitance mode.

MAXIMUM OUTPUT POWER AND SOURCE/SINK LIMITS²: 30.3W per channel maximum. ±20.2V @ ±1.5A, ±20.2V @ ±100mA, four quadrant source or sink operation.

VOLTAGE REGULATION: Line: 0.01% of range. Load: ±(0.01% of range + 100μV).

NOISE 10Hz–20MHz: <20mV peak-peak (typical), <3mV RMS (typical), 20V range.

CURRENT LIMIT/COMPLIANCE³: Bipolar current limit (compliance) set with single value. Minimum value is 10nA. Accuracy is the same as current source.

OVERSHOOT: ≤±(0.1% + 10mV) (typical). Step size = 10% to 90% of range, resistive load, maximum current limit/compliance.

GUARD OFFSET VOLTAGE: <4mV (current <10mA).

CURRENT SOURCE SPECIFICATIONS

CURRENT PROGRAMMING ACCURACY⁴

Range	Programming Resolution	Accuracy (1 Year) 23°C ± 5°C ±(% rdg. + amps)	Typical Noise (Peak-Peak) 0.1Hz–10Hz
100.000 nA	2 pA	0.06% + 100 pA	5 pA
1.00000 μA	20 pA	0.03% + 800 pA	25 pA
10.0000 μA	200 pA	0.03% + 5 nA	60 pA
100.000 μA	2 nA	0.03% + 60 nA	3 nA
1.00000 mA	20 nA	0.03% + 300 nA	6 nA
10.0000 mA	200 nA	0.03% + 6 μA	200 nA
100.000 mA	2 μA	0.03% + 30 μA	600 nA
1.00000 A ⁵	20 μA	0.05% + 1.8 mA	70 μA
1.50000 A ⁵	50 μA	0.06% + 4 mA	150 μA
10.0000 A ^{5,6}	200 μA	0.5% + 40 mA (typical)	

TEMPERATURE COEFFICIENT (0°–18°C & 28°–50°C): ±(0.15 × accuracy specification)°C. Applicable for normal mode only. Not applicable for high capacitance mode.

MAXIMUM OUTPUT POWER AND SOURCE/SINK LIMITS⁵: 30.3W per channel maximum. ±1.515A @ ±20V, ±101mA @ ±200V, four quadrant source or sink operation.

CURRENT REGULATION: Line: 0.01% of range. Load: ±(0.01% of range + 100pA).

VOLTAGE LIMIT/COMPLIANCE⁷: Bipolar voltage limit (compliance) set with a single value. Minimum value is 20mV. Accuracy is the same as current source.

OVERSHOOT: ≤±0.1% (typical). Step size = 10% to 90% of range, resistive load; see CURRENT SOURCE OUTPUT SETTLING TIME for additional test conditions.

ADDITIONAL SOURCE SPECIFICATIONS

TRANSIENT RESPONSE TIME: <70μs for the output to recover to 0.1% for a 10% to 90% step change in load.

VOLTAGE SOURCE OUTPUT SETTLING TIME: Time required to reach 0.1% of final value after source level command is processed on a fixed range.

Range	Settling Time
200 mV	<50 μs (typical)
2 V	<50 μs (typical)
20 V	<110 μs (typical)
200 V	<700 μs (typical)

CURRENT SOURCE OUTPUT SETTLING TIME: Time required to reach 0.1% of final value after source level command is processed on a fixed range. Values below for Iout · Rload = 2V unless noted.

Current Range	Settling Time
1.5 A – 1 A	<120 μs (typical) (Rload > 6Ω)
100 mA – 10 mA	<80 μs (typical)
1 mA	<100 μs (typical)
100 μA	<150 μs (typical)
10 μA	<500 μs (typical)
1 μA	<2 ms (typical)
100 nA	<20 ms (typical)

DC FLOATING VOLTAGE: Output can be floated up to ±250VDC from chassis ground.

REMOTE SENSE OPERATING RANGE⁸: Maximum voltage between HI and SENSE HI = 3V. Maximum voltage between LO and SENSE LO = 3V.

VOLTAGE OUTPUT HEADROOM:

200V Range: Max. output voltage = 202.3V – total voltage drop across source leads (maximum 1Ω per source lead).

20V Range: Max. output voltage = 23.3V – total voltage drop across source leads (maximum 1Ω per source lead).

OVER TEMPERATURE PROTECTION: Internally sensed temperature overload puts unit in standby mode.

VOLTAGE SOURCE RANGE CHANGE OVERSHOOT: <300mV + 0.1% of larger range (typical). Overshoot into a 200kΩ load, 20MHz BW.

CURRENT SOURCE RANGE CHANGE OVERSHOOT: <5% of larger range + 300mV/Rload (typical – With source settling set to SETTLE_SMOOTH_100NA). See CURRENT SOURCE OUTPUT SETTLING TIME for additional test conditions.

PULSE SPECIFICATIONS

Region	Maximum Current Limit	Maximum Pulse Width ⁹	Maximum Duty Cycle ⁹
1	100 mA @ 200 V	DC, no limit	100%
1	1.5 A @ 20 V	DC, no limit	100%
2	1 A @ 180 V	8.5 ms	1%
3 ¹¹	1 A @ 200 V	2.2 ms	1%
4	10 A @ 5 V	1 ms	2.2%

MINIMUM PROGRAMMABLE PULSE WIDTH^{9, 12}: 100μs. NOTE: Minimum pulse width for settled source at a given I/V output and load can be longer than 100μs.

PULSE WIDTH PROGRAMMING RESOLUTION: 1μs.

PULSE WIDTH PROGRAMMING ACCURACY⁹: ±5μs.

PULSE WIDTH JITTER: 2μs (typical).

QUADRANT DIAGRAM:

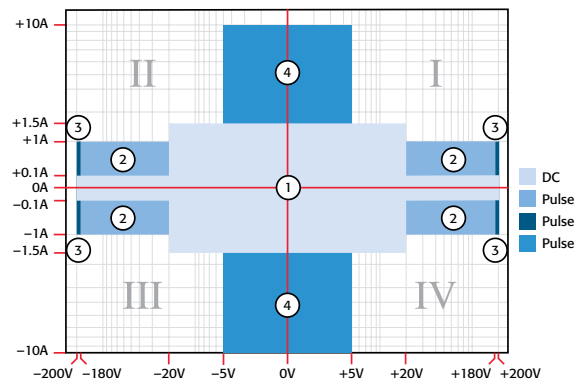

1.888.KEITHLEY (U.S. only)

www.keithley.com

KEITHLEY

2611A 2612A

System SourceMeter® Instruments

SOURCE SPECIFICATIONS (continued)

PULSE SPECIFICATIONS (continued)

NOTES

1. Add 50µV to source accuracy specifications per volt of HI lead drop.
2. Full power source operation regardless of load to 30°C ambient. Above 30°C and/or power sink operation, refer to "Operating Boundaries" in the Series 2600 Reference Manual for additional power derating information.
3. For sink mode operation (quadrants II and IV), add 0.06% of limit range to the corresponding current limit accuracy specifications. Specifications apply with sink mode operation enabled.
4. Accuracy specifications do not include connector leakage. Derate accuracy by $V_{out}/2E11$ per °C when operating between 18°–28°C. Derate accuracy by $V_{out}/2E11 + (0.15 \cdot V_{out}/2E11)$ per °C when operating <18°C and >28°C.
5. Full power source operation regardless of load to 30°C ambient. Above 30°C and/or power sink operation, refer to "Operating Boundaries" in the Series 2600A Reference Manual for additional power derating information.
6. 10A range accessible only in pulse mode.
7. For sink mode operation (quadrants II and IV), add 10% of compliance range and ±0.02% of limit setting to corresponding voltage source specification. For 200mV range add an additional 120mV of uncertainty.
8. Add 50µV to source accuracy specifications per volt of HI lead drop.
9. Times measured from the start of pulse to the start off-time; see figure below.

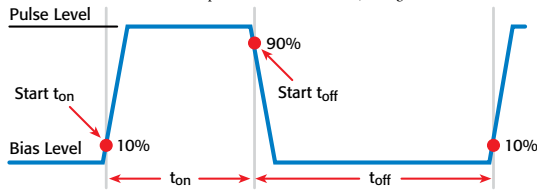

10. Thermally limited in sink mode (quadrants II and IV) and ambient temperatures above 30°C. See power equations in the reference manual for more information.
11. Voltage source operation with 1.5 A current limit.
12. Typical performance for minimum settled pulse widths:

Source Value	Load	Source Settling (% of range)	Min. Pulse Width
5 V	0.5 Ω	1%	300 µs
20 V	200 Ω	0.2%	200 µs
180 V	180 Ω	0.2%	5 ms
200 V (1.5 A Limit)	200 Ω	0.2%	1.5 ms
100 mA	200 Ω	1%	200 µs
1 A	200 Ω	1%	500 µs
1 A	180 Ω	0.2%	5 ms
10 A	0.5 Ω	0.5%	300 µs

Typical tests were performed using remote operation, 4W sense, Keithley 2600-BAN cables and best, fixed measurement range. For more information on pulse scripts, see the Series 2600 Reference Manual.

METER SPECIFICATIONS

VOLTAGE MEASUREMENT ACCURACY^{14, 15}

Range	Display Resolution ¹⁶	Input Resistance	Accuracy (1 Year) 23°C ±5°C ±(% rdg. + volts)
200.000 mV	1 µV	>10 GΩ	0.015% + 225 µV
2.00000 V	10 µV	>10 GΩ	0.02% + 350 µV
20.0000 V	100 µV	>10 GΩ	0.015% + 5 mV
200.000 V	1 mV	>10 GΩ	0.015% + 50 mV

TEMPERATURE COEFFICIENT (0°–18°C & 28°–50°C): ±(0.15 × accuracy specification)/°C. Applicable for normal mode only. Not applicable for high capacitance mode.

CURRENT MEASUREMENT ACCURACY^{15, 16}

Range	Display Resolution ¹⁷	Voltage Burden ¹⁸	Accuracy (1 Year) 23°C ±5°C ±(% rdg. + amps)
100.000 nA	1 pA	<1 mV	0.06% + 100 pA
1.00000 µA	10 pA	<1 mV	0.025% + 500 pA
10.0000 µA	100 pA	<1 mV	0.025% + 1.5 nA
100.000 µA	1 nA	<1 mV	0.02% + 25 nA
1.00000 mA	10 nA	<1 mV	0.02% + 200 nA
10.0000 mA	100 nA	<1 mV	0.02% + 2.5 µA
100.000 mA	1 µA	<1 mV	0.02% + 20 µA
1.00000 A	10 µA	<1 mV	0.03% + 1.5 mA
1.50000 A	10 µA	<1 mV	0.05% + 3.5 mA
10.0000 A ¹⁹	100 µA	<1 mV	0.4% + 25 mA (typical)

CURRENT MEASURE SETTLING TIME (Time for measurement to settle after a Vstep)²⁰: Time required to reach 0.1% of final value after source level command is processed on a fixed range. Values for V_{out} = 2V unless noted. **Current Range:** 1mA. **Settling Time:** <100µs (typical).

TEMPERATURE COEFFICIENT (0°–18°C & 28°–50°C): ±(0.15 × accuracy specification)/°C. Applicable for normal mode only. Not applicable for high capacitance mode.

CONTACT CHECK²¹

Speed	Maximum Measurement Time to Memory For 60Hz (50Hz) ⁴	Accuracy (1 Year) 23°C ±5°C ±(%rdg. + ohms)
FAST	1 (1.2) ms	5% + 10 Ω
MEDIUM	4 (5) ms	5% + 1 Ω
SLOW	36 (42) ms	5% + 0.3 Ω

ADDITIONAL METER SPECIFICATIONS

MAXIMUM LOAD IMPEDANCE:

Normal Mode: 10nF (typical). High Capacitance Mode: 50µF (typical).

COMMON MODE VOLTAGE: 250VDC.

COMMON MODE ISOLATION: >1GΩ, <4500pF.

OVERRANGE: 101% of source range, 102% of measure range.

MAXIMUM SENSE LEAD RESISTANCE: 1kΩ for rated accuracy.

SENSE INPUT IMPEDANCE: >10GΩ.

NOTES

14. Add 50µV to source accuracy specifications per volt of HI lead drop.
15. De-rate accuracy specifications for NPLC setting <1 by increasing error term. Add appropriate % of range term using table below.

NPLC Setting	200mV Range	2V–200V Ranges	100nA Range	1µA–100mA Ranges	1A–1.5A Ranges
0.1	0.01%	0.01%	0.01%	0.01%	0.01%
0.01	0.08%	0.07%	0.1%	0.05%	0.05%
0.001	0.8 %	0.6 %	1%	0.5 %	1.1 %

16. De-rate accuracy by $V_{out}/2E11$ per °C when operating between 18°C - 28°C. Derate accuracy by $V_{out}/2E11 + (0.15 \cdot V_{out}/2E11)$ per °C when operating < 18°C and > 28°C.
17. Applies when in single channel display mode.
18. Four-wire remote sense only and with current meter mode selected. Voltage measure set to 100mV or 1V range only.
19. 10A range accessible only in pulse mode.
20. Compliance equal to 100mA.
21. Includes measurement of SENSE HI to HI and SENSE LO to LO contact resistances.

1.888.KEITHLEY (U.S. only)

www.keithley.com

KEITHLEY

2611A 2612A

System SourceMeter® Instruments

HIGH CAPACITANCE MODE²²

VOLTAGE SOURCE OUTPUT SETTLING TIME: Time required to reach 0.1% of final value after source level command is processed on a fixed range. Current limit = 1A.

Voltage Source Range	Settling Time with $C_{load} = 4.7\mu\text{F}$
200 mV	600 μs (typical)
2 V	600 μs (typical)
20 V	1.5 ms (typical)
200 V	20 ms (typical)

CURRENT MEASURE SETTLING TIME: Time required to reach 0.1% of final value after voltage source is stabilized on a fixed range. Values below for $V_{out} = 1\text{V}$ unless noted.

Current Measure Range	Settling Time
1.5 A – 1 A	<120 μs (typical) (Rload >6 Ω)
100 mA – 10 mA	<100 μs (typical)
1 mA	< 3 ms (typical)
100 μA	< 3 ms (typical)
10 μA	< 230 ms (typical)
1 μA	< 230 ms (typical)

CAPACITOR LEAKAGE PERFORMANCE USING HIGH-C SCRIPTS²³: Load = $5\mu\text{F} \parallel 10\text{M}\Omega$.

Test: 5V step and measure. 200ms (typical) @ 50nA.

MODE CHANGE DELAY: 500ms. Voltage Source with High Capacitance Mode ON to Voltage Source with High Capacitance Mode OFF. Voltage Source with High Capacitance Mode ON to Current Source with High Capacitance Mode OFF.

VOLTMETER INPUT IMPEDANCE: 30G Ω in parallel with 3300pF.

VOLTAGE SOURCE RANGE CHANGE OVERTHOOT: <400mV + 0.1% of larger range (typical). Overshoot into a 200k Ω load, 20MHz BW.

NOTES

22. 100nA range is not available in High Capacitance Mode.

23. Part of KI Factory scripts. See reference manual for details.

GENERAL

IEEE-488: IEEE-488.1 compliant. Supports IEEE-488.2 common commands and status model topology.

RS-232: Baud rates from 300bps to 115200bps. Programmable number of data bits, parity type, and flow control (RTS/CTS hardware or none). When not programmed as the active host interface, the SourceMeter instrument can use the RS-232 interface to control other instrumentation.

ETHERNET: RJ-45 connector, LXI Class C, 10/100BT, no auto MDIX.

EXPANSION INTERFACE: The TSP-Link expansion interface allows TSP enabled instruments to trigger and communicate with each other.

Cable Type: Category 5e or higher LAN crossover cable.

Length: 3 meters maximum between each TSP enabled instrument.

LXI COMPLIANCE: LXI Class C 1.2.

LXI TIMING: Total Output Trigger Response Time: 245 μs min., 280 μs typ., (not specified) max. Receive LAN[0-7] Event Delay: Unknown. Generate LAN[0-7] Event Delay: Unknown.

DIGITAL I/O INTERFACE:

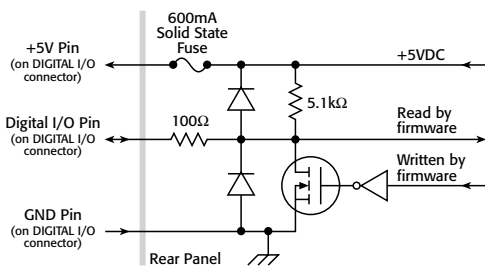

Connector: 25-pin female D.

Input/Output Pins: 14 open drain I/O bits.

Absolute Maximum Input Voltage: 5.25V.

Absolute Minimum Input Voltage: -0.25V.

Maximum Logic Low Input Voltage: 0.7V, +850 μA max.

Minimum Logic High Input Voltage: 2.1V, +570 μA .

Maximum Source Current (flowing out of Digital I/O bit): +960 μA .

Maximum Sink Current @ Maximum Logic Low Voltage (0.7V): -5.0mA.

Absolute Maximum Sink Current (flowing into Digital I/O pin): -11mA.

5V Power Supply Pin: Limited to 600mA, solid state fuse protected.

Safety Interlock Pin: Active high input. >3.4V @ 24mA (absolute maximum of 6V) must be externally applied to this pin to ensure 200V operation. This signal is pulled down to chassis ground with a 10k Ω resistor. 200V operation will be blocked when the INTERLOCK signal is <0.4V (absolute minimum -0.4V). See figure below:

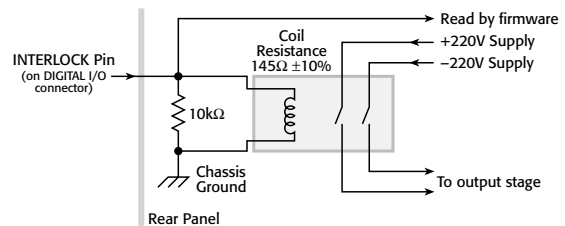

USB: USB 1.0 Host Controller (Memory Stick I/O).

POWER SUPPLY: 100V to 250VAC, 50–60Hz (auto sensing), 240VA max.

COOLING: Forced air. Side intake and rear exhaust. One side must be unobstructed when rack mounted.

EMC: Conforms to European Union Directive 2004/108/EEC, EN 61326-1.

SAFETY: Conforms to European Union Directive 73/23/EEC, EN 61010-1, and UL 61010-1.

DIMENSIONS: 89mm high × 213mm wide × 460mm deep (3½ in × 8¾ in × 17½ in). Bench Configuration (with handle & feet): 104mm high × 238mm wide × 460mm deep (4¼ in × 9¾ in × 17½ in).

WEIGHT: 2611A: 4.75kg (10.4 lbs). 2612A: 5.50kg (12.0 lbs).

ENVIRONMENT: For indoor use only.

Altitude: Maximum 2000 meters above sea level.

Operating: 0°–50°C, 70% R.H. up to 35°C. Derate 3% R.H./°C, 35°–50°C.

Storage: -25°C to 65°C.

SEE PAGES 15 AND 16 FOR MEASUREMENT SPEEDS AND OTHER SPECIFICATIONS.

1.888.KEITHLEY (U.S. only)

www.keithley.com

KEITHLEY

2635A 2636A

System SourceMeter® Instruments

SPECIFICATION CONDITIONS

This document contains specifications and supplemental information for the Models 2635A and 2636A System SourceMeters instruments. Specifications are the standards against which the Models 2635A and 2636A are tested. Upon leaving the factory the 2635A and 2636A meet these specifications. Supplemental and typical values are non-warranted, apply at 23°C, and are provided solely as useful information.

Accuracy specifications are applicable for both normal and high capacitance modes.

The source and measurement accuracies are specified at the SourceMeter CHANNEL A (2635A and 2636A) or SourceMeter CHANNEL B (2636A) terminals under the following conditions:

1. 23°C ± 5°C, <70% relative humidity.
2. After 2 hour warm-up.
3. Speed normal (1 NPLC).
4. A/D auto-zero enabled.
5. Remote sense operation or properly zeroed local sense operation.
6. Calibration period = 1 year.

SOURCE SPECIFICATIONS

VOLTAGE SOURCE SPECIFICATIONS

VOLTAGE PROGRAMMING ACCURACY¹

Range	Programming Resolution	Accuracy (1 Year) 23°C ± 5°C ±(% rdg. + volts)	Typical Noise (peak-peak) 0.1Hz–10Hz
200.000 mV	5 μV	0.02% + 375 μV	20 μV
2.00000 V	50 μV	0.02% + 600 μV	50 μV
20.0000 V	500 μV	0.02% + 5 mV	300 μV
200.000 V	5 mV	0.02% + 50 mV	2 mV

TEMPERATURE COEFFICIENT (0°–18°C & 28°–50°C): ±(0.15 × accuracy specification)/°C. Applicable for normal mode only. Not applicable for high capacitance mode.

MAXIMUM OUTPUT POWER AND SOURCE/SINK LIMITS²: 30.3W per channel maximum. ±20.2V @ ±1.5A, ±202V @ ±100mA, four quadrant source or sink operation.

VOLTAGE REGULATION: Line: 0.01% of range. **Load:** ±(0.01% of range + 100μV).

NOISE 10Hz–20MHz: <20mV pk-pk (typical), <3mV rms (typical), 20V range.

CURRENT LIMIT/COMPLIANCE³: Bipolar current limit (compliance) set with single value. Minimum value is 100pA. Accuracy is the same as current source.

OVERSHOOT: <±(0.1% + 10mV) typical (step size = 10% to 90% of range, resistive load, maximum current limit/compliance).

GUARD OFFSET VOLTAGE: <4mV (current <10mA).

CURRENT SOURCE SPECIFICATIONS

CURRENT PROGRAMMING ACCURACY

Range	Programming Resolution	Accuracy (1 Year) 23°C ± 5°C ±(% rdg. + amps)	Typical Noise (peak-peak) 0.1Hz–10Hz
1.00000 nA	20 fA	0.15% + 2 pA	800 fA
10.0000 nA	200 fA	0.15% + 5 pA	2 pA
100.000 nA	2 pA	0.06% + 50 pA	5 pA
1.00000 μA	20 pA	0.03% + 700 pA	25 pA
10.0000 μA	200 pA	0.03% + 5 nA	60 pA
100.000 μA	2 nA	0.03% + 60 nA	3 nA
1.00000 mA	20 nA	0.03% + 300 nA	6 nA
10.0000 mA	200 nA	0.03% + 6 μA	200 nA
100.000 mA	2 μA	0.03% + 30 μA	600 nA
1.00000 A ²	20 μA	0.05% + 1.8 mA	70 μA
1.50000 A ²	50 μA	0.06% + 4 mA	150 μA
10.0000 A ^{4,5}	200 μA	0.05% + 40mA (typical)	

TEMPERATURE COEFFICIENT (0°–18°C & 28°–50°C): ±(0.15 × accuracy specification)/°C. Applicable for normal mode only. Not applicable for high capacitance mode.

MAXIMUM OUTPUT POWER AND SOURCE/SINK LIMITS²: 30.3W per channel maximum. ±1.515A @ ±20V, ±101mA @ ±200V, four quadrant source or sink operation.

CURRENT REGULATION: Line: 0.01% of range. **Load:** ±(0.01% of range + 100μV).

VOLTAGE LIMIT/COMPLIANCE⁶: Bipolar voltage limit (compliance) set with a single value. Minimum value is 20mV. Accuracy is the same as voltage source.

OVERSHOOT: <0.1% typical (step size = 10% to 90% of range, resistive load, maximum current limit/compliance; see CURRENT SOURCE OUTPUT SETTLING TIME for additional test conditions).

ADDITIONAL SOURCE SPECIFICATIONS

TRANSIENT RESPONSE TIME: <70μs for the output to recover to 0.1% for a 10% to 90% step change in load.

VOLTAGE SOURCE OUTPUT SETTLING TIME: Time required to reach 0.1% of final value after source level command is processed on a fixed range.

Range	Settling Time
200 mV	<50 μs (typical)
2 V	<50 μs (typical)
20 V	<110 μs (typical)
200 V	<700 μs (typical)

CURRENT SOURCE OUTPUT SETTLING TIME: Time required to reach 0.1% of final value after source level command is processed on a fixed range. Values below for Iout · Rload = 2V unless noted.

Current Range	Settling Time
1.5 A – 1 A	<120 μs (typical) (Rload > 6Ω)
100 mA – 10 mA	<80 μs (typical)
1 mA	<100 μs (typical)
100 μA	<150 μs (typical)
10 μA	<500 μs (typical)
1 μA	<2 ms (typical)
100 nA	<20 ms (typical)
10 nA	<40 ms (typical)
0 nA	<150 ms (typical)

DC FLOATING VOLTAGE: Output can be floated up to ±250VDC.

REMOTE SENSE OPERATING RANGE⁷: Maximum voltage between HI and SENSE HI = 3V. Maximum voltage between LO and SENSE LO = 3V.

VOLTAGE OUTPUT HEADROOM:

200V Range: Max. output voltage = 202.3V – total voltage drop across source leads (maximum 1Ω per source lead).

20V Range: Max. output voltage = 23.3V – total voltage drop across source leads (maximum 1Ω per source lead).

OVER TEMPERATURE PROTECTION: Internally sensed temperature overload puts unit in standby mode.

VOLTAGE SOURCE RANGE CHANGE OVERTHOOT: 300mV + 0.1% of larger range (typical). Overshoot into a 200kΩ load, 20MHz BW.

CURRENT SOURCE RANGE CHANGE OVERTHOOT: <5% of larger range + 300mV/Rload (typical – With source settling set to SETTLE_SMOOTH_100NA). See CURRENT SOURCE OUTPUT SETTLING TIME for additional test conditions.

PULSE SPECIFICATIONS

Region	Maximum Current Limit	Maximum Pulse Width ⁸	Maximum Duty Cycle ⁹
1	100 mA @ 200 V	DC, no limit	100%
1	1.5 A @ 20 V	DC, no limit	100%
2	1 A @ 180 V	8.5 ms	1%
3 ¹⁰	1 A @ 200 V	2.2 ms	1%
4	10 A @ 5 V	1 ms	2.2%

MINIMUM PROGRAMMABLE PULSE WIDTH^{8, 11}: 100μs. NOTE: Minimum pulse width for settled source at a given I/V output and load can be longer than 100μs.

PULSE WIDTH PROGRAMMING RESOLUTION: 1μs.

PULSE WIDTH PROGRAMMING ACCURACY⁸: ±5μs.

PULSE WIDTH JITTER: 50μs (typical).

QUADRANT DIAGRAM:

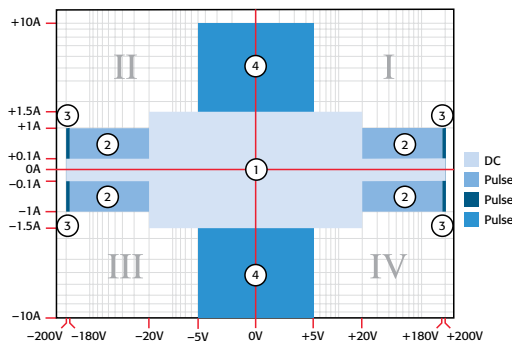

1.888.KEITHLEY (U.S. only)

www.keithley.com

KEITHLEY

A GREATER MEASURE OF CONFIDENCE

SOURCE SPECIFICATIONS (continued)

PULSE SPECIFICATIONS (continued)

NOTES

1. Add 50µV to source accuracy specifications per volt of HI lead drop.
2. Full power source operation regardless of load to 30°C ambient. Above 30°C and/or power sink operation, refer to "Operating Boundaries" in the Series 2600 Reference Manual for additional power derating information.
3. For sink mode operation (quadrants II and IV), add 0.06% of limit range to the corresponding current limit accuracy specifications. Specifications apply with sink mode operation enabled.
4. Full power source operation regardless of load to 30°C ambient. Above 30°C and/or power sink operation, refer to "Operating Boundaries" in the Series 2600A Reference Manual for additional power derating information.
5. 10A range accessible only in pulse mode.
6. For sink mode operation (quadrants II and IV), add 10% of compliance range and ±0.02% of limit setting to corresponding voltage source specification. For 200mV range add an additional 120mV of uncertainty.
7. Add 50µV to source accuracy specifications per volt of HI lead drop.
8. Times measured from the start of pulse to the start off-time; see figure below.

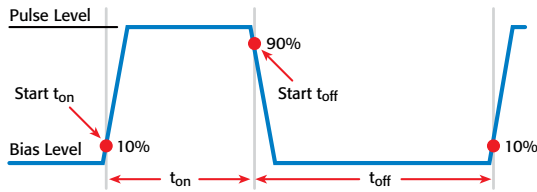

9. Thermally limited in sink mode (quadrants 2 and 4) and ambient temperatures above 30°C. See power equations in the Reference Manual for more information.
10. Voltage source operation with 1.5 A current limit.
11. Typical performance for minimum settled pulse widths:

Source Value	Load	Source Settling (% of range)	Min. Pulse Width
5 V	0.5 Ω	1%	300 µs
20 V	200 Ω	0.2%	200 µs
180 V	180 Ω	0.2%	5 ms
200 V (1.5 A Limit)	200 Ω	0.2%	1.5 ms
100 mA	200 Ω	1%	200 µs
1 A	200 Ω	1%	500 µs
1 A	180 Ω	0.2%	5 ms
10 A	0.5 Ω	0.5%	300 µs

Typical tests were performed using remote operation, 4W sense, Keithley 2600-BAN cables and best, fixed measurement range. For more information on pulse scripts, see the Series 2600 Reference Manual.

METER SPECIFICATIONS

VOLTAGE MEASUREMENT ACCURACY^{13, 14}

Range	Display Resolution ³	Input Resistance	Accuracy (1 Year) 23°C ±5°C ±(% rdg. + volts)
200.000 mV	1 µV	>10 ¹⁴ Ω	0.015% + 225 µV
2.00000 V	10 µV	>10 ¹⁴ Ω	0.02% + 350 µV
20.0000 V	100 µV	>10 ¹⁴ Ω	0.015% + 5 mV
200.000 V	1 mV	>10 ¹⁴ Ω	0.015% + 50 mV

TEMPERATURE COEFFICIENT (0°–18°C & 28°–50°C): ±(0.15 × accuracy specification)/°C. Applicable for normal mode only. Not applicable for high capacitance mode.

CURRENT MEASUREMENT ACCURACY¹⁴

Range	Display Resolution ¹⁵	Voltage Burden ¹⁶	Accuracy (1 Year) 23°C ±5°C ±(% rdg. + amps)
100.00 pA ^{17, 18}	1 fA	<1 mV	0.15% + 120 fA
1.00000 nA ^{17, 19}	10 fA	<1 mV	0.15% + 240 fA
10.0000 nA	100 fA	<1 mV	0.15% + 3 pA
100.000 nA	1 pA	<1 mV	0.06% + 40 pA
1.00000 µA	10 pA	<1 mV	0.025% + 400 pA
10.0000 µA	100 pA	<1 mV	0.025% + 1.5 nA
100.000 µA	1 nA	<1 mV	0.02% + 25 nA
1.00000 mA	10 nA	<1 mV	0.02% + 200 nA
10.0000 mA	100 nA	<1 mV	0.02% + 2.5 µA
100.000 mA	1 µA	<1 mV	0.02% + 20 µA
1.00000 A	10 µA	<1 mV	0.03% + 1.5 mA
1.50000 A	10 µA	<1 mV	0.05% + 3.5 mA
10.0000 A ²⁰	100 µA	<1 mV	0.04% + 25 mA

CURRENT MEASURE SETTLING TIME (Time for measurement to settle after a Vstep)²⁰: Time required to reach 0.1% of final value after source level command is processed on a fixed range. Values for Vout = 2V unless noted. Current Range: 1mA. Settling Time: <100µs (typical).

TEMPERATURE COEFFICIENT (0°–18°C & 28°–50°C): ±(0.15 × accuracy specification)/°C. Applicable for normal mode only. Not applicable for high capacitance mode.

CONTACT CHECK²²

Speed	Maximum Measurement Time to Memory For 60Hz (50Hz) ⁴	Accuracy (1 Year) 23°C ±5°C ±(%rdg. + ohms)
FAST	1 (1.2) ms	5% + 10 Ω
MEDIUM	4 (5) ms	5% + 1 Ω
SLOW	36 (42) ms	5% + 0.3 Ω

ADDITIONAL METER SPECIFICATIONS

MAXIMUM LOAD IMPEDANCE:

Normal Mode: 10nF (typical). High Capacitance Mode: 50µF (typical).

COMMON MODE VOLTAGE: 250VDC.

COMMON MODE ISOLATION: >1GΩ, <4500pF.

OVERRANGE: 101% of source range, 102% of measure range.

MAXIMUM SENSE LEAD RESISTANCE: 1kΩ for rated accuracy.

SENSE INPUT IMPEDANCE: >10¹⁴Ω.

NOTES

13. Add 50µV to source accuracy specifications per volt of HI lead drop.
14. De-rate accuracy specifications for NPLC setting <1 by increasing error term. Add appropriate % of range term using table below.

NPLC Setting	200mV Range	2V–200V Ranges	100nA Range	1µA–100mA Ranges	1A–1.5A Ranges
0.1	0.01%	0.01%	0.01%	0.01%	0.01%
0.01	0.08%	0.07%	0.1%	0.05%	0.05%
0.001	0.8 %	0.6 %	1%	0.5 %	1.1 %

15. Applies when in single channel display mode.
16. Four-wire remote sense only and with current meter mode selected. Voltage measure set to 100mV or 1V range only.
17. 10-NPLC, 11-Point Median Filter, <200V range, measurements made within 1 hour after zeroing. 23°C ± 1°C
18. Under default specification conditions: ±(0.15% + 750fA).
19. Under default specification conditions: ±(0.15% + 1pA).
20. 10A range accessible only in pulse mode.
21. Delay factor set to 1. Compliance equal to 100mA.
22. Includes measurement of SENSE HI to HI and SENSE LO to LO contact resistances.

2635A 2636A

System SourceMeter® Instruments

HIGH CAPACITANCE MODE²²

VOLTAGE SOURCE OUTPUT SETTLING TIME: Time required to reach 0.1% of final value after source level command is processed on a fixed range. Current limit = 1A.

Voltage Source Range	Settling Time with $C_{load} = 4.7\mu F$
200 mV	600 μs (typical)
2 V	600 μs (typical)
20 V	1.5 ms (typical)
200 V	20 ms (typical)

CURRENT MEASURE SETTLING TIME: Time required to reach 0.1% of final value after voltage source is stabilized on a fixed range. Values below for $V_{out} = 1V$ unless noted.

Current Measure Range	Settling Time
1.5 A – 1 A	<120 μs (typical) (Rload >6 Ω)
100 mA – 10 mA	<100 μs (typical)
1 mA	< 3 ms (typical)
100 μA	< 3 ms (typical)
10 μA	< 230 ms (typical)
1 μA	< 230 ms (typical)

CAPACITOR LEAKAGE PERFORMANCE USING HIGH-C SCRIPTS²³: Load = $5\mu F || 10M\Omega$.

Test: 5V step and measure. 200ms (typical) @ 50nA.

MODE CHANGE DELAY: 500ms. Voltage Source with High Capacitance Mode ON to Voltage Source with High Capacitance Mode OFF. Voltage Source with High Capacitance Mode ON to Current Source with High Capacitance Mode OFF.

VOLTMETER INPUT IMPEDANCE: 30G Ω in parallel with 3300pF.

VOLTAGE SOURCE RANGE CHANGE OVERSHOOT: <400mV + 0.1% of larger range (typical). Overshoot into a 200k Ω load, 20MHz BW.

NOTES

22. 100nA range is not available in high capacitance mode.

23. Part of KI Factory scripts. See reference manual for details.

Series 2600A specifications

GENERAL

IEEE-488: IEEE-488.1 compliant. Supports IEEE-488.2 common commands and status model topology.

RS-232: Baud rates from 300bps to 115200bps. Programmable number of data bits, parity type, and flow control (RTS/CTS hardware or none). When not programmed as the active host interface, the SourceMeter instrument can use the RS-232 interface to control other instrumentation.

ETHERNET: RJ-45 connector, LXI Class C, 10/100BT, no auto MDIX.

EXPANSION INTERFACE: The TSP-Link expansion interface allows TSP enabled instruments to trigger and communicate with each other.

Cable Type: Category 5e or higher LAN crossover cable.

Length: 3 meters maximum between each TSP enabled instrument.

LXI COMPLIANCE: LXI Class C 1.2.

LXI TIMING: Total Output Trigger Response Time: 245 μs min., 280 μs typ., (not specified) max. Receive LAN[0-7] Event Delay: Unknown. Generate LAN[0-7] Event Delay: Unknown.

DIGITAL I/O INTERFACE:

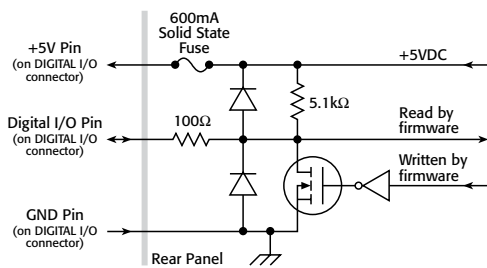

Connector: 25-pin female D.

Input/Output Pins: 14 open drain I/O bits.

Absolute Maximum Input Voltage: 5.25V.

Absolute Minimum Input Voltage: -0.25V.

Maximum Logic Low Input Voltage: 0.7V, +850 μA max.

Minimum Logic High Input Voltage: 2.1V, +570 μA .

Maximum Source Current (flowing out of Digital I/O bit): +960 μA .

Maximum Sink Current @ Maximum Logic Low Voltage (0.7V): -5.0mA.

Absolute Maximum Sink Current (flowing into Digital I/O pin): -11mA.

5V Power Supply Pin: Limited to 600mA, solid state fuse protected.

Safety Interlock Pin: Active high input. >3.4V @ 24mA (absolute maximum of 6V) must be externally applied to this pin to ensure 200V operation. This signal is pulled down to chassis ground with a 10k Ω resistor. 200V operation will be blocked when the INTERLOCK signal is <0.4V (absolute minimum -0.4V). See figure below:

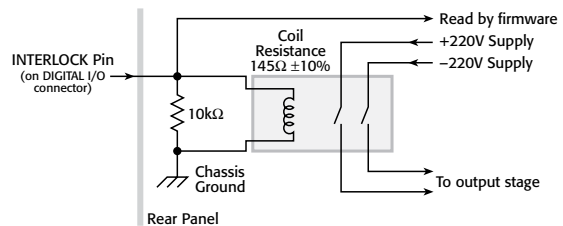

USB: USB 1.0 Host Controller (Memory Stick I/O).

POWER SUPPLY: 100V to 250VAC, 50–60Hz (auto sensing), 240VA max.

COOLING: Forced air. Side intake and rear exhaust. One side must be unobstructed when rack mounted.

EMC: Conforms to European Union Directive 2004/108/EEC, EN 61326-1.

SAFETY: Conforms to European Union Directive 73/23/EEC, EN 61010-1, and UL 61010-1.

DIMENSIONS: 89mm high × 213mm wide × 460mm deep (3½ in × 8¾ in × 17½ in). Bench Configuration (with handle & feet): 104mm high × 238mm wide × 460mm deep (4¼ in × 9¾ in × 17½ in).

WEIGHT: 2635A: 4.75kg (10.4 lbs). 2636A: 5.50kg (12.0 lbs).

ENVIRONMENT: For indoor use only.

Altitude: Maximum 2000 meters above sea level.

Operating: 0°–50°C, 70% R.H. up to 35°C. Derate 3% R.H./°C, 35°–50°C.

Storage: -25°C to 65°C.

SEE PAGES 15 AND 16 FOR MEASUREMENT SPEEDS AND OTHER SPECIFICATIONS.

1.888.KEITHLEY (U.S. only)

www.keithley.com

KEITHLEY

A GREATER MEASURE OF CONFIDENCE

Series 2600A

System SourceMeter® Instruments

Applicable to Models

2601A, 2602A, 2611A, 2612A, 2635A, and 2636A

SPEED SPECIFICATIONS 1, 2, 3

MAXIMUM SWEEP OPERATION RATES (operations per second) FOR 60Hz (50Hz):

A/D Converter Speed	Trigger Origin	Measure To Memory Using User Scripts	Measure To GPIB Using User Scripts	Source Measure To Memory Using User Scripts	Source Measure To GPIB Using User Scripts	Source Measure To Memory Using Sweep API	Source Measure To GPIB Using Sweep API
0.001 NPLC	Internal	20000 (20000)	105000 (105000)	7000 (7000)	6200 (6200)	12000 (12000)	5900 (5900)
0.001 NPLC	Digital I/O	8100 (8100)	7100 (7100)	5500 (5500)	5100 (5100)	11200 (11200)	5700 (5700)
0.01 NPLC	Internal	5000 (4000)	4000 (3500)	3400 (3000)	3200 (2900)	4200 (3700)	3100 (2800)
0.01 NPLC	Digital I/O	3650 (3200)	3400 (3000)	3000 (2700)	2900 (2600)	4150 (3650)	3050 (2775)
0.1 NPLC	Internal	580 (490)	560 (475)	550 (465)	550 (460)	575 (480)	545 (460)
0.1 NPLC	Digital I/O	560 (470)	450 (460)	545 (460)	540 (450)	570 (480)	545 (460)
1.0 NPLC	Internal	59 (49)	59 (49)	59 (49)	59 (49)	59 (49)	59 (49)
1.0 NPLC	Digital I/O	58 (48)	58 (48)	59 (48)	59 (49)	59 (49)	59 (49)

MAXIMUM SINGLE MEASUREMENT RATES (operations per second) FOR 60Hz (50Hz):

A/D Converter Speed	Trigger Origin	Measure To GPIB	Source Measure To GPIB	Source Measure Pass/Fail To GPIB
0.001 NPLC	Internal	1900 (1800)	1400 (1400)	1400 (1400)
0.01 NPLC	Internal	1450 (1400)	1200 (1100)	1100 (1100)
0.1 NPLC	Internal	450 (390)	425 (370)	425 (375)
1.0 NPLC	Internal	58 (48)	57 (48)	57 (48)

MAXIMUM MEASUREMENT RANGE CHANGE RATE: $<150\mu\text{s}$ for ranges $>10\mu\text{A}$, typical. When changing to or from a range $\geq 1\text{A}$, maximum rate is $<450\mu\text{s}$, typical.

MAXIMUM SOURCE RANGE CHANGE RATE: $<2.5\text{ms}$ for ranges $>10\mu\text{A}$, typical. When changing to or from a range $\geq 1\text{A}$, maximum rate is $<5.2\text{ms}$, typical.

MAXIMUM SOURCE FUNCTION CHANGE RATE: $<1\text{ms}$, typical.

COMMAND PROCESSING TIME: Maximum time required for the output to begin to change following the receipt of the `smux.source.levelv` or `smux.source.levelvi` command. $<1\text{ms}$ typical.

NOTES

1. See the Speed Specifications Test Conditions Appendix E in the Series 2600A Reference Manual for more information regarding test conditions.
2. Exclude current measurement ranges less than 1mA .
3. 2635A/2636A with default measurement delays and filters disabled.

TRIGGERING AND SYNCHRONIZATION SPECIFICATIONS

TRIGGERING:

Trigger in to trigger out: $0.5\mu\text{s}$, typical.

Trigger in to source change:⁴ $10\mu\text{s}$, typical.

Trigger Timer accuracy: $\pm 2\mu\text{s}$, typical.

Source change⁴ after LXI Trigger: $280\mu\text{s}$, typical.

SYNCHRONIZATION:

Single-node synchronized source change:⁴ $<0.5\mu\text{s}$, typical.

Multi-node synchronized source change:⁴ $<0.5\mu\text{s}$, typical.

NOTES

4. Fixed source range, with no polarity change.

1.888.KEITHLEY (U.S. only)

www.keithley.com

KEITHLEY

A GREATER MEASURE OF CONFIDENCE

Series 2600A

System SourceMeter® Instruments

Applicable to Models

2601A, 2602A, 2611A, 2612A, 2635A, and 2636A

SUPPLEMENTAL INFORMATION

FRONT PANEL INTERFACE: Two-line vacuum fluorescent display (VFD) with keypad and rotary knob.

Display:

- Show error messages and user defined messages
- Display source and limit settings
- Show current and voltage measurements
- View measurements stored in non-volatile reading buffers

Keypad Operations:

- Change host interface settings
- Save and restore instrument setups
- Load and run factory and user defined test scripts (i.e. sequences) that prompt for input and send results to the display
- Store measurements into non-volatile reading buffers

PROGRAMMING: Embedded Test Script Processor (TSP) accessible from any host interface. Responds to individual instrument control commands. Responds to high speed test scripts comprised of instrument control commands and Test Script Language (TSL) statements (e.g. branching, looping, math, etc.). Able to execute high speed test scripts stored in memory without host intervention.

Minimum Memory Available: 16MB (approximately 250,000 lines of TSL code).

Test Script Builder: Integrated Development Environment for building, running, and managing TSP scripts. Includes an Instrument Console for communicating with any TSP enabled instrument in an interactive manner. Requires:

- VISA (NI-VISA included on CD)
- Microsoft .NET Framework (included on CD)
- Keithley I/O Layer (included on CD)
- Pentium III 800MHz or faster personal computer
- Microsoft® Windows® 98, NT, 2000, or XP

Software Interface: Direct GPIB/VISA READ/WRITE for VB, VC/C++, LabVIEW, LabWindows/CVI, etc.

READING BUFFERS: Dedicated storage area(s) reserved for measurement data. Reading buffers are arrays of measurement elements. Each element can hold the following items:

- Measurement
- Measurement status
- Timestamp
- Source setting (at the time the measurement was taken)
- Range information

Two reading buffers are reserved for each SourceMeter channel. Reading buffers can be filled using the front panel STORE key and retrieved using the RECALL key or host interface.

Buffer Size, with timestamp and source setting: >60,000 samples.

Buffer Size, without timestamp and source setting: >140,000 samples.

SYSTEM EXPANSION: The TSP-Link expansion interface allows TSP enabled instruments to trigger and communicate with each other. See figure below:

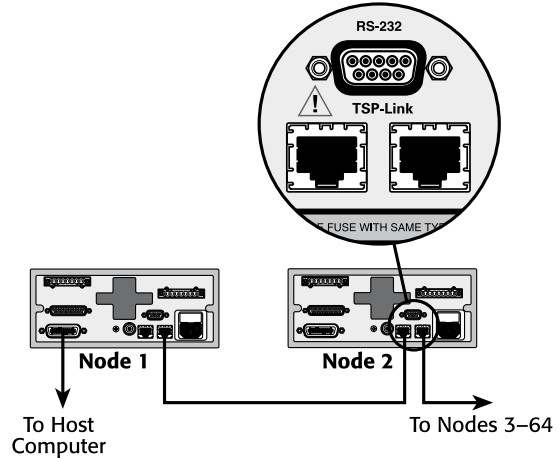

- Each SourceMeter instrument has two TSP-Link connectors to facilitate chaining instruments together.
 - Once SourceMeter instruments are interconnected via TSP-Link, a computer can access all of the resources of each SourceMeter instrument via the host interface of any SourceMeter instrument.
 - A maximum of 32 TSP-Link nodes can be interconnected. Each SourceMeter instrument consumes one TSP-Link node.
- TIMER:** Free running 47-bit counter with 1MHz clock input. Reset each time instrument powers up. Rolls over every 4 years.
- Timestamp:** TIMER value automatically saved when each measurement is triggered.
- Resolution:** 1µs.
- Accuracy:** ±100ppm.

Specifications are subject to change without notice.
All Keithley trademarks and trade names are the property of Keithley Instruments, Inc.
All other trademarks and trade names are the property of their respective companies.

KEITHLEY

A G R E A T E R M E A S U R E O F C O N F I D E N C E

KEITHLEY INSTRUMENTS, INC. ■ 28775 AURORA ROAD ■ CLEVELAND, OHIO 44139-1891 ■ 440-248-0400 ■ Fax: 440-248-6168 ■ 1-888-KEITHLEY ■ www.keithley.com

BELGIUM

Sint-Pieters-Leeuw
Ph: 02-3630040
Fax: 02-3630064
info@keithley.nl
www.keithley.nl

CHINA

Beijing
Ph: 8610-82255010
Fax: 8610-82255018
china@keithley.com
www.keithley.com.cn

FINLAND

Espoo
Ph: 09-88171661
Fax: 09-88171662
finland@keithley.com
www.keithley.com

FRANCE

Saint-Aubin
Ph: 01-64532020
Fax: 01-60117726
info@keithley.fr
www.keithley.fr

GERMANY

Germering
Ph: 089-84930740
Fax: 089-84930734
info@keithley.de
www.keithley.de

INDIA

Bangalore
Ph: 080-26771071, -72, -73
Fax: 080-26771076
support_india@keithley.com
www.keithley.com

ITALY

Peschiera Borromeo (Mi)
Ph: 02-5538421
Fax: 02-55384228
info@keithley.it
www.keithley.it

JAPAN

Tokyo
Ph: 81-3-5733-7555
Fax: 81-3-5733-7556
info.jp@keithley.com
www.keithley.jp

KOREA

Seoul
Ph: 82-2-574-7778
Fax: 82-2-574-7838
keithley@keithley.co.kr
www.keithley.co.kr

MALAYSIA

Penang
Ph: 60-4-656-2592
Fax: 60-4-656-3794
chan_patrick@keithley.com
www.keithley.com

NETHERLANDS

Gorinchem
Ph: 0183-635333
Fax: 0183-630821
info@keithley.nl
www.keithley.nl

SINGAPORE

Singapore
Ph: 65-6747-9077
Fax: 65-6747-2991
koh_william@keithley.com
www.keithley.com.sg

SWEDEN

Solna
Ph: 08-50904600
Fax: 08-6552610
sweden@keithley.com
www.keithley.com

SWITZERLAND

Zürich
Ph: 044-8219444
Fax: 044-8203081
info@keithley.ch
www.keithley.ch

TAIWAN

Hsinchu
Ph: 886-3-572-9077
Fax: 886-3-572-9031
info.kei@keithley.com.tw
www.keithley.com.tw

UNITED KINGDOM

Theale
Ph: 0118-9297500
Fax: 0118-9297519
info@keithley.co.uk
www.keithley.co.uk