

# 2401

## Low Voltage SourceMeter® Instrument



- **1 $\mu$ V–20V and 10pA–1A precision voltage and current sourcing and measurement capabilities**
- **Five instruments in one (IV Source, IVR Measure)**
- **Source and sink (4-quadrant) operation**
- **0.012% basic measure accuracy with 5½-digit resolution**
- **2-, 4-, and 6-wire remote V-source and measure sensing**
- **1700 readings/second at 4½ digits via GPIB**
- **Standard SCPI GPIB, RS-232, and Keithley Trigger Link interfaces**
- **Keithley LabTracer 2.0 I-V curve tracing application software (download)**

### The Lowest Cost Precision SMU (source measurement unit) on the Market

The Model 2401 is the lowest cost precision SMU instrument on the market, offering an economical 20W I-V source/measure alternative to configuring systems and test benches with separate programmable power supplies and digital multimeters. The Model 2401 also offers an economical alternative for applications for which precision programmable power supplies cannot deliver sufficient accuracy, signal range, source setting, or readback resolution.

The Model 2401 offers users all the same accuracy, speed, and measurement functions as the rest of the instruments in the Series 2400 family. It shares a common operating code base with the rest of the family, so it can be operated and programmed within its range boundaries just like any other Series 2400 instrument. The only functional differences between the Model 2401 and the Model 2400 are that the Model 2401 does not include 200V source and measure ranges or back panel Digital I/O port capabilities. (However, the DB-9 connector is still provided to provide test fixture interlock signals.)

### Model 2401 Applications

Manufacturers of components and modules for the communications, semiconductor, computer, automotive, and medical industries will find the Model 2401 invaluable for a wide range of characterization and production test applications. Its 20V@1A output makes it ideal for characterizing the current-voltage (I-V) performance of photovoltaic (solar) cells, high brightness LEDs (HBLEDs), low voltage materials, CMOS circuits and low-power semiconductor devices, as well as resistance measurements on these devices.

The Model 2401 is well suited for use as a gate bias in applications involving devices with three or more terminals such as HBLEDs and photovoltaic cells, reducing total system hardware costs. It also provides sufficient range for characterizing low voltage materials and devices (including graphene and other nano- and MEMs-type structures), which are inherently low voltage oriented.

The economical Model 2401 is the latest member of Keithley's Series 2400 SourceMeter family, designed specifically for low voltage test applications that demand tightly coupled sourcing and measurement. Like all Series 2400 SourceMeter models, the Model 2401 provides precision voltage and current sourcing and measurement capabilities (1 $\mu$ V–20V and 10pA–1A). It is both a highly stable DC power source and a true instrument-grade 5½-digit multimeter. The power source characteristics include low noise, precision, and readback. The multimeter capabilities include high repeatability and low noise. The result is a compact, single-channel, DC parametric tester. In operation, it can act as a voltage source, a current source, a voltage meter, a current meter, and an ohmmeter.

### TYPICAL APPLICATIONS

- **High brightness LED (DC and pulse)**
- **Photovoltaic cell efficiency (source and sink)**
- **Precision DC power supply/current measure**
- **Discrete semiconductor devices**
- **Passive devices**
- **Laser diodes, laser diode modules, LEDs, photodetectors**
- **Connectors, switches, relays**
- **Low voltages/resistances**
- **LIV**
- **IDDQ**
- **I-V characterization**

Tightly coupled precision sourcing and measurement

SOURCE AND MEASURE

1.888.KEITHLEY (U.S. only)

[www.keithley.com](http://www.keithley.com)

KEITHLEY

A GREATER MEASURE OF CONFIDENCE

**2401****Ordering Information****2401 Low Voltage SourceMeter® Instrument****Accessories Supplied****Model 8605 Test Leads  
LabVIEW Software Driver  
(downloadable)****ACCESSORIES AVAILABLE****TEST LEADS AND PROBES**

1754	2-Wire Universal 10-Piece Test Lead Kit
5804	Kelvin (4-Wire) Universal 10-Piece Test Lead Kit
5805	Kelvin (4-Wire) Spring-Loaded Probes
5808	Low Cost Single-pin Kelvin Probe Set
5809	Low Cost Kelvin Clip Lead Set
8607	2-Wire, 1000V Banana Cables, 1m (3.3 ft)
CA-18-1	Shielded Dual Banana Cable, 1.2m (4 ft)

**SWITCHING HARDWARE**

7001	Two-Slot Switch System
7002	Ten-Slot Switch System
7019-C	6-Wire Ohms Switch Card
7053	High-Current Switch Card

**CABLES/ADAPTERS**

7007-1	Shielded GPIB Cable, 1m (3.3 ft)
7007-2	Shielded GPIB Cable, 2m (6.6 ft)
7009-5	RS-232 Cable
8620	Shorting Plug

**COMMUNICATION INTERFACE**

KPCI-488LPA	IEEE-488 Interface/Controller for the PCI Bus
KUSB-488B	IEEE-488 USB-to-GPIB Interface Adapter

**TRIGGERING AND CONTROL**

8501-1	Trigger Link Cable, DIN-to-DIN, 1m (3.3 ft)
8501-2	Trigger Link Cable, DIN-to-DIN, 2m (6.6 ft)
8502	Trigger Link to BNC Breakout Box
8503	Trigger Link Cable, DIN-to-Dual BNC, 1m (3.3 ft)
8505	Male to 2-Female Y-DIN Cable for Trigger Link

**RACK MOUNT KITS**

4288-1	Single Fixed Rack Mount Kit
4288-2	Dual Fixed Rack Mount Kit
4288-4	Dual Fixed Rack Mount Kit
4288-5	Shelf Type Side by Side Rack Mounting Kit
4288-9	Dual Fixed Rack Mounting Kit

**SOFTWARE**

LabTracer 2.0	Curve Tracing Software (downloadable)
---------------	---------------------------------------

**SERVICES AVAILABLE**

2401-3Y-EW	1-year factory warranty extended to 3 years from date of shipment
TRN-2400-1C	Course: Unleashing the Power of Your SourceMeter Instrument

# Low Voltage SourceMeter® Instrument

**Advantages of a Tightly Integrated Instrument**

By linking source and measurement circuitry in a single unit, the Model 2401 offers a variety of advantages over systems configured with separate source and measurement instruments. For example, it minimizes the time required for test station development, setup, and maintenance, while lowering the overall cost of system ownership. It simplifies the test process itself by eliminating many of the complex synchronization and connection issues associated with using multiple instruments. Its compact half-rack size conserves precious “real estate” in the test rack or bench.

**Much More than a Power Supply**

The tightly coupled nature of a SourceMeter instrument provides many advantages over solutions configured from separate instruments such as a precision power supply and a digital multimeter. For example, the Model 2401 provides faster test times by reducing GPIB traffic and simplifies the remote programming interface. It also protects the device under test from damage due to accidental overloads, thermal runaway, etc. Both the Model 2401's current and voltage source are programmable with readback to help maximize device measurement integrity. If the readback reaches a programmed compliance limit, then the source is clamped at the limit, providing fault protection.

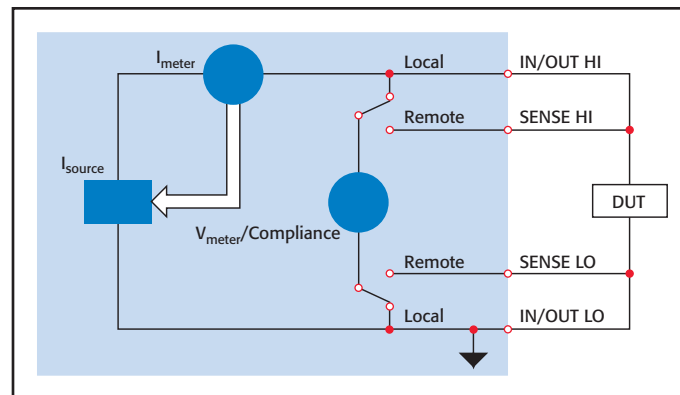
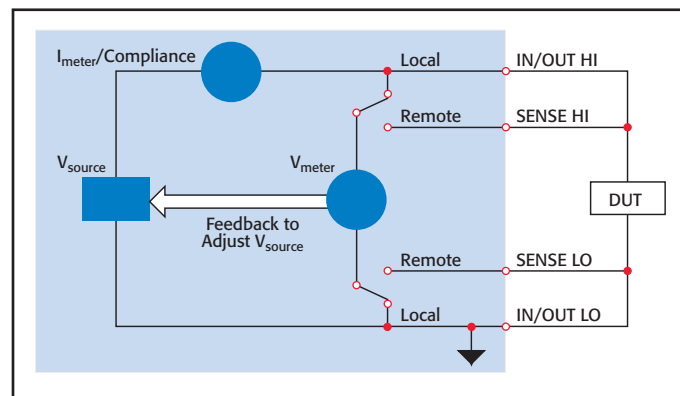
**Source I, Measure V, I, or  $\Omega$  configuration****Source V, Measure I, V, or  $\Omega$  configuration****1.888.KEITHLEY** (U.S. only)**www.keithley.com****KEITHLEY**

A GREATER MEASURE OF CONFIDENCE

## I-V Characteristics

Like all Series 2400 SourceMeter instruments, the Model 2401 provides four-quadrant operation. In the first and third quadrants, it operates as a source, delivering power to a load. In the second and fourth quadrants, it operates as a sink, dissipating power internally. Voltage, current, and resistance can be measured during source or sink operation.

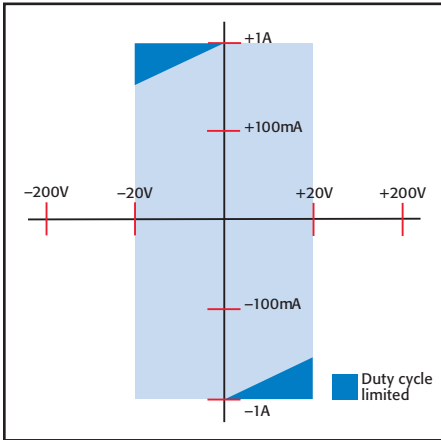

Model 2401 four-quadrant operation

## Built-In Test Sequencer (Source Memory List)

The Source Memory list provides faster and easier testing by allowing you to set up and execute up to 100 different tests that run without PC intervention.

- Stores up to 100 instrument configurations, each containing source settings, measurement settings, pass/fail criteria, etc.
- Pass/fail limit test as fast as 500µs per point
- Onboard comparator eliminates the delay caused when sending data to the computer for analysis
- Built-in, user-definable math functions to calculate derived parameters

## Example Test Sequence

Test	Pass/Fail Test	If Passes Test	If Fails Test
Test 1	Check $V_{F1}$ at 100mA against pass/fail limits	Go to Test 2	1. Bin part to bad bin 2. Transmit data to computer while handler is placing new part 3. Return to Test 1
Test 2	Check $V_{F2}$ at 1A against pass/fail limits	Go to Test 3	
Test 3	Check leakage current at -500V and test against pass/fail limits	1. Bin part to good bin 2. Transmit readings to computer while handler is placing new part 3. Return to Test 1	

## Trigger Link Interface

All SourceMeter instruments include Keithley's unique Trigger Link interface, which provides high speed, seamless communications with many of Keithley's other instruments. For example, use the Trigger Link interface to connect a SourceMeter instrument with a Series 7000 Switching System for a complete multipoint test solution. With Trigger Link, Series 7000 Switching Systems can be controlled by a SourceMeter instrument during a high speed test sequence independent of a computer and GPIB.

## Automation for Speed

A SourceMeter instrument streamlines production testing. It sources voltage or current while making measurements without needing to change connections. It is designed for reliable operation in non-stop production environments. To provide the throughput demanded by production applications, the SourceMeter instrument offers many built-in features that allow it to run complex test sequences without computer control or GPIB communications slowing things down.

## Standard and Custom Sweeps

Sweep solutions greatly accelerate testing with automation hooks. Three basic sweep waveforms are provided that can be programmed for single-event or continuous operation. They are ideal for I/V, I/R, V/I, and V/R characterization.

- Linear Staircase Sweep: Moves from the start level to the stop level in equal linear steps
- Logarithmic Staircase Sweep: Done on a log scale with a specified number of steps per decade
- Custom Sweep: Allows construction of special sweeps by specifying the number of measurement points and the source level at each point
- Up to 1700 readings/second at 4½ digits to the GPIB bus
- 5000 5½-digit readings can be stored in the non-volatile buffer memory

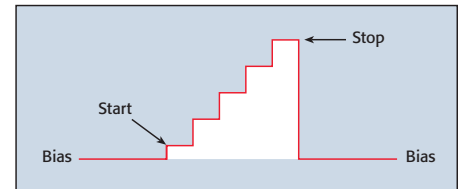

Linear staircase sweep

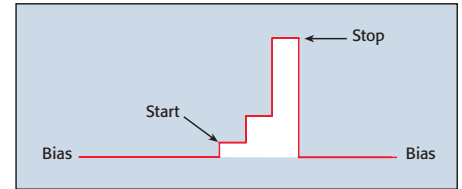

Logarithmic staircase sweep

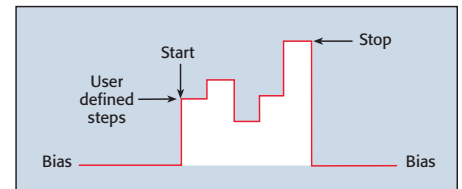

Custom sweep

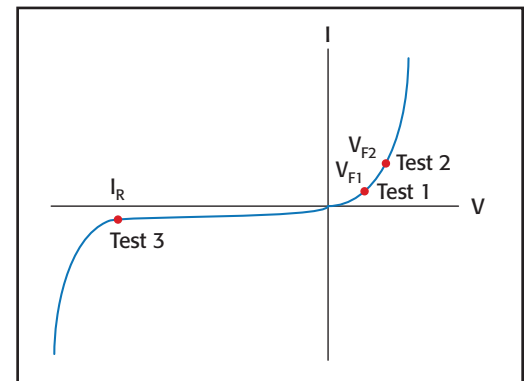

### Unique 6-Wire Ohms Technique

The Model 2401 can make standard 4-wire, split Kelvin, and 6-wire, guarded ohms measurements and can be configured for either the constant current or constant voltage method. The 6-wire ohms technique:

- Uses guard and guard sense leads in addition to the 4-wire sense and source leads
- Locks out parallel current paths when measuring resistor networks or hybrid circuits to isolate the component under test
- Allows users to configure and plot data easily from Series 2400 SourceMeter instruments, making characterization of 2-, 3-, and 4-terminal devices a snap

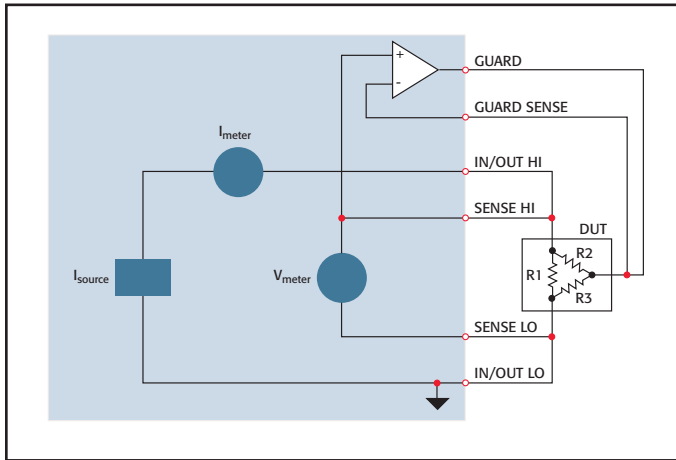

**6-Wire Ohms Circuit.** All test current flows through R1 because the high current guard drives the voltage across R2 to 0V.

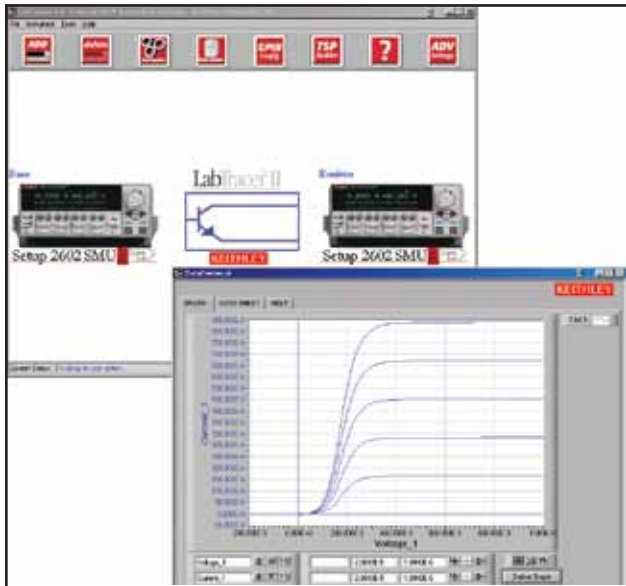

Free LabTracer 2.0 device characterization software (downloadable).

### Advantages of a Tightly Integrated Instrument

By linking source and measurement circuitry in a single unit, these instruments offer a variety of advantages over systems configured with separate source and measurement instruments. For example, they minimize the time required for test station development, setup, and maintenance, while lowering the overall cost of system ownership. They simplify the test process itself by eliminating many of the complex synchronization and connection issues associated with using multiple instruments. And, their compact half-rack size conserves precious “real estate” in the test rack or bench.

### Power of Five Instruments in One (IV Source, IVR Measure)

The tightly coupled nature of a SourceMeter instrument provides many advantages over separate instruments. For example, it provides faster test times by reducing GPIB traffic and simplifies the remote programming interface. It also protects the device under test from damage due to accidental overloads, thermal runaway, etc. Both the current and voltage source are programmable with readback to help maximize device measurement integrity. If the readback reaches a programmed compliance limit, then the source is clamped at the limit, providing fault protection.

Unlike narrow-performance SMU platforms, including board-level products, which often deliver sub-optimal analog measurements due to significant loss in signal integrity, accuracy, power, and/or speed due to interconnect, thermal management, and other issues, all Series 2400 SourceMeter instruments combine the industry’s widest dynamic range with uncompromising throughput and superior measurement integrity.

1.888.KEITHLEY (U.S. only)

[www.keithley.com](http://www.keithley.com)

**KEITHLEY**

A GREATER MEASURE OF CONFIDENCE

## Other Series 2400 SourceMeter Instruments

If your application requires a wider sourcing or measurement range than the Model 2401 can provide, other Series 2400 instruments likely offer the range you need. Consult the range graphs shown here or the instrument specifications for details. Series 2600A System SourceMeter instruments are also available to address applications that require integrating multiple source and measure channels and/or pulsing capabilities.

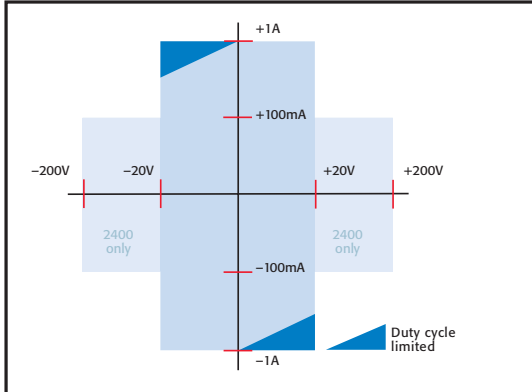

Model 2400 and 2400-LV SourceMeter Instruments.

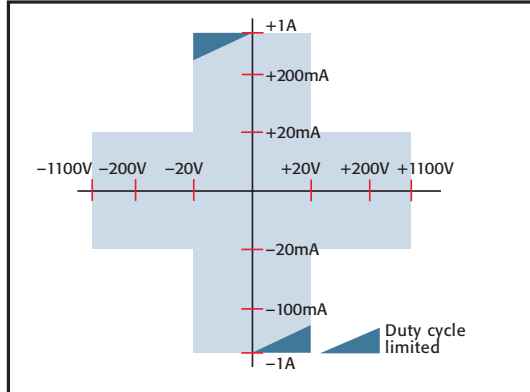

Model 2410 High-Voltage SourceMeter Instrument.

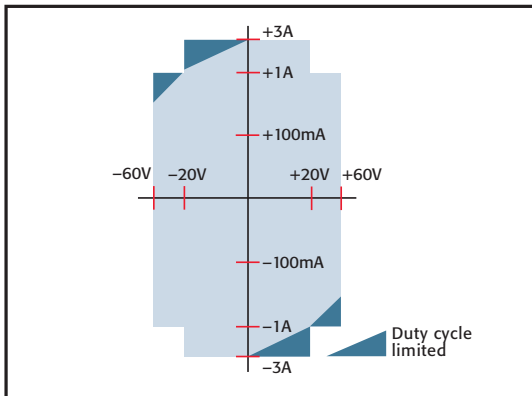

Model 2420 3A SourceMeter Instrument.

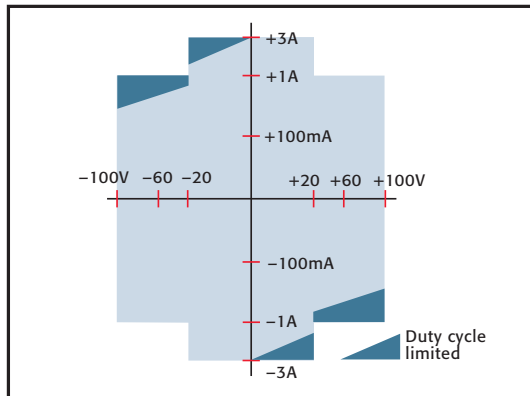

Model 2425 100W SourceMeter Instrument.

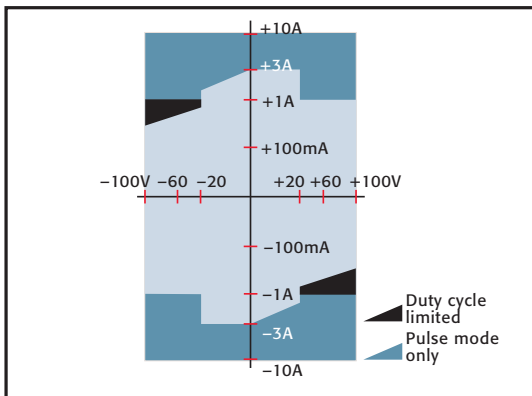

Model 2430 1kW Pulse Mode SourceMeter Instrument.

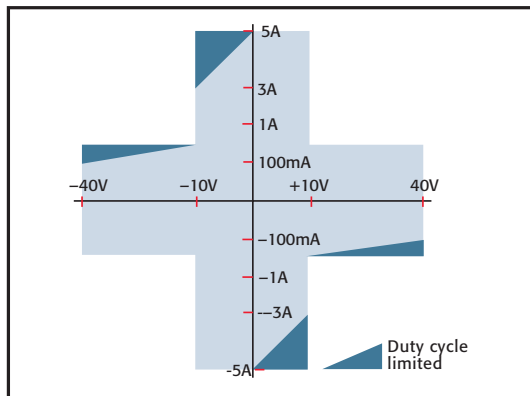

Model 2440 5A SourceMeter Instrument.



## Voltage Accuracy (Local or Remote Sense)

Model	Range	Programming Resolution	Source <sup>1</sup> Accuracy (1 Year) 23°C ±5°C ±(% rdg. + volts)	Default Measurement Resolution	Measurement <sup>2,3,4</sup> Accuracy (1 Year) 23°C ±5°C ±(% rdg. + volts)	Output Slew Rate (±30%)	Source/Sink Limit
2400, 2400-C	200.000 mV	5 μV	0.02% + 600 μV	1 μV	0.012% + 300 μV		
	2.00000 V	50 μV	0.02% + 600 μV	10 μV	0.012% + 300 μV		±21 V @ ±1.05 A
	20.0000 V	500 μV	0.02% + 2.4 mV	100 μV	0.015% + 1.5 mV	0.08 V/μs	±210 V @ ±105 mA
	200.000 V	5 mV	0.02% + 24 mV	1 mV	0.015% + 10 mV	0.5 V/μs	
2401	200.000 mV	5 μV	0.02% + 600 μV	1 μV	0.012% + 300 μV		
	2.00000 V	50 μV	0.02% + 600 μV	10 μV	0.012% + 300 μV		±21 V @ ±1.05 A
	20.0000 V	500 μV	0.02% + 2.4 mV	100 μV	0.015% + 1.5 mV	0.08 V/μs	

TEMPERATURE COEFFICIENT (0°–18°C and 28°–50°C): ±(0.15 × accuracy specification)/°C.

VOLTAGE REGULATION: Line: 0.01% of range. Load: 0.01% of range + 100μV.

OVER VOLTAGE PROTECTION: User selectable values, 5% tolerance. Factory default = none.

CURRENT LIMIT: Bipolar current limit (compliance) set with single value. Min. 0.1% of range.

OVERSHOOT: <0.1% typical (full scale step, resistive load, 10mA range).

### NOTES

- 2400, 2410 Only: Specifications valid for continuous output currents below 105mA. For operation above 105mA continuous for >1 minute, derate accuracy 10%/35mA above 105mA.
- Speed = Normal (1 PLC). For 0.1 PLC, add 0.005% of range to offset specifications, except 200mV, 1A, 10A ranges, add 0.05%. For 0.01 PLC, add 0.05% of range to offset specifications, except 200mV, 1A, 10A ranges, add 0.5%.
- Accuracies apply to 2- or 4-wire mode when properly zeroed.
- In pulse mode, limited to 0.1 PLC measurement.

## ADDITIONAL SOURCE SPECIFICATIONS (All Models)

TRANSIENT RESPONSE TIME: 30μs minimum for the output to recover to its spec. following a step change in load.

COMMAND PROCESSING TIME: Maximum time required for the output to begin to change following the receipt of :SOURce:VOLTage|CURRENT <nrf> command. **Autorange On:** 10ms. **Autorange Off:** 7ms.

OUTPUT SETTLING TIME: Time required to reach 0.1% of final value after command is processed. 100μs typical. Resistive load. 10μA to 100mA range.

DC FLOATING VOLTAGE: Output can be floated up to ±250VDC (Model 2440 ±40VDC) from chassis ground.

REMOTE SENSE: Up to 1V drop per load lead.

COMPLIANCE ACCURACY: Add 0.3% of range and ±0.02% of reading to base specification.

OVER TEMPERATURE PROTECTION: Internally sensed temperature overload puts unit in standby mode.

RANGE CHANGE OVERSHOOT: Overshoot into a fully resistive 100kΩ load, 10Hz to 1MHz BW, adjacent ranges: 100mV typical, except 20V/200V (20V/60V on Model 2420), 20V/100V on Model 2425 and 2430, range boundary, and Model 2440.

MINIMUM COMPLIANCE VALUE: 0.1% of range.

## Current Accuracy (Local or Remote Sense)

Model	Range	Programming Resolution	Source <sup>1,3</sup> Accuracy (1 Year) <sup>3</sup> 23°C ±5°C ±(% rdg. + amps)	Default Measurement Resolution	Measurement <sup>4,5,6</sup> Accuracy (1 Year) 23°C ±5°C ±(% rdg. + amps)	Source/Sink Limit
2400, 2400-C, 2401	1.00000 μA	50 pA	0.035% + 600 pA	10 pA	0.029% + 300 pA	
	10.0000 μA	500 pA	0.033% + 2 nA	100 pA	0.027% + 700 pA	
	100.000 μA	5 nA	0.031% + 20 nA	1 nA	0.025% + 6 nA	
	1.00000 mA	50 nA	0.034% + 200 nA	10 nA	0.027% + 60 nA	±1.05A @ ±21 V
	10.0000 mA	500 nA	0.045% + 2 μA	100 nA	0.035% + 600 nA	
	100.000 mA	5 μA	0.066% + 20 μA	1 μA	0.055% + 6 μA	
	1.00000 A <sup>2</sup>	50 μA	0.27 % + 900 μA	10 μA	0.22 % + 570 μA	

TEMPERATURE COEFFICIENT (0°–18°C and 28°–50°C): ±(0.15 × accuracy specification)/°C.

CURRENT REGULATION: Line: 0.01% of range. Load: 0.01% of range (except Model 2440 5A range 0.05%) + 100pA.

VOLTAGE LIMIT: Bipolar voltage limit (compliance) set with single value. Min. 0.1% of range.

OVERSHOOT: <0.1% typical (1mA step, RL = 10kΩ, 20V range for Model 2400, 2410, 2420, 2425, 2430), (10V range for Model 2440).

## CONTACT CHECK SPECIFICATIONS (requires -C version)

(Not available for Model 2401)

SPEED: 350μs for verification and notification.

CONTACT CHECK:	2 Ω	15 Ω	50 Ω
No contact check failure	<1.00 Ω	<13.5 Ω	<47.5 Ω
Always contact check failure	>3.00 Ω	>16.5 Ω	>52.5 Ω

### NOTES

- 2400, 2401, 2410 Only: Specifications valid for continuous output currents below 105mA. For operation above 105mA continuous for >1 minute, derate accuracy 10%/35mA above 105mA.
- Full operation (1A) regardless of load to 30°C (50°C for Model 2420 and 2440). Above 30°C (50°C for Model 2420 and 2440) ambient, derate 35mA/°C and prorate 35mA/Ω load. 4-wire mode. For current sink operation on 1A, 3A, or 5A ranges, maximum continuous power is limited to approximately 1/2 rated power or less, depending on current, up to 30°C ambient. See power equations in the User's Manual to calculate allowable duty cycle for specific conditions.
- For sink mode, 1μA to 100mA range, accuracy is:  
Model 2400, 2401: ±(0.15% + offset\*4). Models 2410, 2420, 2425, 2430, 2440: ±(0.5% + offset\*3).  
For 1A range, accuracy is:  
Model 2400, 2401: ±(1.5% + offset\*8). Models 2410, 2420, 2425, 2430, 2440: ±(1.5% + offset\*3).
- Speed = Normal (1 PLC). For 0.1 PLC, add 0.005% of range to offset specifications, except 200mV, 1A, 10A ranges, add 0.05%. For 0.01 PLC, add 0.05% of range to offset specifications, except 200mV, 1A, 10A ranges, add 0.5%.
- Accuracies apply to 2- or 4-wire mode when properly zeroed.
- In pulse mode, limited to 0.1 PLC measurement.

## Resistance Measurement Accuracy (Local or Remote Sense)<sup>1, 2, 5</sup>

Range	Default Resolution	Default Test Current 2400, 2401	Normal Accuracy (23°C ± 5°C)	Enhanced Accuracy (23°C ± 5°C) <sup>4</sup>
			1 Year, ±(% rdg. + ohms) 2400, 2401	1 Year, ±(% rdg. + ohms) 2400, 2401
<0.20000 Ω <sup>3</sup>	–	–	Source I <sub>ACC</sub> + Meas. V <sub>ACC</sub>	Source I <sub>ACC</sub> + Meas. V <sub>ACC</sub>
2.00000 Ω <sup>3</sup>	10 μΩ	–	Source I <sub>ACC</sub> + Meas. V <sub>ACC</sub>	Source I <sub>ACC</sub> + Meas. V <sub>ACC</sub>
20.0000 Ω	100 μΩ	100 mA	0.10% + 0.003 Ω	0.07% + 0.001 Ω
200.000 Ω	1 mΩ	10 mA	0.08% + 0.03 Ω	0.05% + 0.01 Ω
2.00000 kΩ	10 mΩ	1 mA	0.07% + 0.3 Ω	0.05% + 0.1 Ω
20.0000 kΩ	100 mΩ	100 μA	0.06% + 3 Ω	0.04% + 1 Ω
200.000 kΩ	1 Ω	10 μA	0.07% + 30 Ω	0.05% + 10 Ω
2.00000 MΩ <sup>6</sup>	10 Ω	1 μA	0.11% + 300 Ω	0.05% + 100 Ω
20.0000 MΩ <sup>7</sup>	100 Ω	1 μA	0.11% + 1 kΩ	0.05% + 500 Ω
200.000 MΩ <sup>3</sup>	1 kΩ	100 nA	0.66% + 10 kΩ	0.35% + 5 kΩ
>200.000 MΩ <sup>3</sup>	–	–	Source I <sub>ACC</sub> + Meas. V <sub>ACC</sub>	Source I <sub>ACC</sub> + Meas. V <sub>ACC</sub>

TEMPERATURE COEFFICIENT (0°–18°C and 28°–50°C):  
±(0.15 × accuracy specification)<sup>5</sup>/°C.

SOURCE I MODE, MANUAL OHMS: Total uncertainty = I source accuracy + V measure accuracy (4-wire remote sense).

SOURCE V MODE, MANUAL OHMS: Total uncertainty = V source accuracy + I measure accuracy (4-wire remote sense).

6-WIRE OHMS MODE: Available using active ohms guard and guard sense. Max. Guard Output Current: 50mA (except 1A range). Accuracy is load dependent. Refer to White Paper no. 2033 for calculation formula.

GUARD OUTPUT IMPEDANCE: <0.1Ω in ohms mode.

### NOTES

- Speed = Normal (1 PLC). For 0.1 PLC, add 0.005% of range to offset specifications, except 200mV, 1A, 10A ranges, add 0.05%. For 0.01 PLC, add 0.05% of range to offset specifications, except 200mV, 1A, 10A ranges, add 0.5%.
- Accuracies apply to 2- or 4-wire mode when properly zeroed.
- Manual ohms only – except 2420, 2425, 2430, 2440 for 2Ω range and 2410 or 2400 for 200MΩ range.
- Source readback enabled, offset compensation ON. Also available on 2410, 2420, 2425, 2430, and 2440 with similar accuracy enhancement.
- In pulse mode, limited to 0.1 PLC measurement.
- Except 2440; default test current is 5μA.
- Except 2440; default test current is 0.5μA.

## System Speeds

### MEASUREMENT<sup>1</sup>

MAXIMUM RANGE CHANGE RATE: 75/second.

MAXIMUM MEASURE AUTORANGE TIME: 40ms (fixed source).<sup>2</sup>

### Sweep Operation<sup>3</sup> Reading Rates (rdg./second) for 60Hz (50Hz):

Speed	NPLC/Trigger Origin	Measure		Source-Measure		Source-Measure <sup>5</sup> Pass/Fail Test <sup>4, 5</sup>		Source-Memory <sup>4</sup>	
		To Mem.	To GPIB	To Mem.	To GPIB	To Mem.	To GPIB	To Mem.	To GPIB
Fast	0.01 / internal	2081 (2030)	1754	1551 (1515)	1369	902 (900)	981	165 (162)	165
IEEE-488.1 Mode	0.01 / external	1239 (1200)	1254	1018 (990)	1035	830 (830)	886	163 (160)	163
Fast	0.01 / internal	2081 (2030)	1198 (1210)	1551 (1515)	1000 (900)	902 (900)	809 (840)	165 (162)	164 (162)
IEEE-488.2 Mode	0.01 / external	1239 (1200)	1079 (1050)	1018 (990)	916 (835)	830 (830)	756 (780)	163 (160)	162 (160)
Medium	0.10 / internal	510 (433)	509 (433)	470 (405)	470 (410)	389 (343)	388 (343)	133 (126)	132 (126)
IEEE-488.2 Mode	0.10 / external	438 (380)	438 (380)	409 (360)	409 (365)	374 (333)	374 (333)	131 (125)	131 (125)
Normal	1.00 / internal	59 (49)	59 (49)	58 (48)	58 (48)	56 (47)	56 (47)	44 (38)	44 (38)
IEEE-488.2 Mode	1.00 / external	57 (48)	57 (48)	57 (48)	57 (47)	56 (47)	56 (47)	44 (38)	44 (38)

### Single Reading Operation Reading Rates (rdg./second) for 60Hz (50Hz):

Speed	NPLC/Trigger Origin	Measure To GPIB	Source-Measure <sup>5</sup> To GPIB	Source-Measure Pass/Fail Test <sup>4, 5</sup> To GPIB
Fast (488.1)	0.01 / internal	537	140	135
Fast (488.2)	0.01 / internal	256 (256)	79 (83)	79 (83)
Medium (488.2)	0.10 / internal	167 (166)	72 (70)	69 (70)
Normal (488.2)	1.00 / internal	49 (42)	34 (31)	35 (30)

### Component for 60Hz (50Hz):<sup>4, 6</sup>

Speed	NPLC/Trigger Origin	Measure To GPIB	Source Pass/Fail Test	Source-Measure Pass/Fail Test <sup>5, 7</sup> To GPIB
Fast	0.01 / external	1.04 ms (1.08 ms)	0.5 ms (0.5 ms)	4.82 ms (5.3 ms)
Medium	0.10 / external	2.55 ms (2.9 ms)	0.5 ms (0.5 ms)	6.27 ms (7.1 ms)
Normal	1.00 / external	17.53 ms (20.9 ms)	0.5 ms (0.5 ms)	21.31 ms (25.0 ms)

### NOTES

<sup>1</sup> Reading rates applicable for voltage or current measurements. Auto zero off, autorange off, filter off, display off, trigger delay = 0, and binary reading format.

<sup>2</sup> Purely resistive load. 1μA and 10μA ranges <65ms.

<sup>3</sup> 1000 point sweep was characterized with the source on a fixed range.

<sup>4</sup> Pass/Fail test performed using one high limit and one low math limit.

<sup>5</sup> Includes time to re-program source to a new level before making measurement.

<sup>6</sup> Time from falling edge of START OF TEST signal to falling edge of END OF TEST signal.

<sup>7</sup> Command processing time of :SOURCE:VOLTage|CURRENT:TRIGgered <nrf> command not included.

## GENERAL

### Noise Rejection:

	NPLC	NMRR	CMRR
Fast	0.01	—	80 dB
Medium	0.1	—	80 dB
Slow	1	60 dB	100 dB <sup>1</sup>

<sup>1</sup>Except lowest 2 current ranges = 90dB.

**LOAD IMPEDANCE:** Stable into 20,000pF typical.

**COMMON MODE VOLTAGE:** 250V DC (40V DC for Model 2440).

**COMMON MODE ISOLATION:** >10<sup>3</sup>Ω, <1000pF.

**OVERRRANGE:** 105% of range, source and measure.

**MAX. VOLTAGE DROP BETWEEN INPUT/OUTPUT AND SENSE TERMINALS:** 5V.

**MAX. SENSE LEAD RESISTANCE:** 1MΩ for rated accuracy.

**SENSE INPUT IMPEDANCE:** >10<sup>10</sup>Ω.

**GUARD OFFSET VOLTAGE:** <150μV, typical (300μV for Models 2430, 2440).

### SOURCE OUTPUT MODES:

- Fixed DC level
- Memory List (mixed function)
- Stair (linear and log)

**MEMORY BUFFER:** 5,000 readings @ 5 digits (two 2,500 point buffers). Includes selected measured value(s) and time stamp. Lithium battery backup (3 yr+ battery life).

**SOURCE MEMORY LIST:** 100 points max.

**PROGRAMMABILITY:** IEEE-488 (SCPI-1995.0), RS-232, 5 user-definable power-up states plus factory default and \*RST.

**DIGITAL INTERFACE: Interlock:** Active low input. **Note:** DIO Post N/A.

**POWER SUPPLY:** 100V to 240V rms, 50–60Hz (automatically detected at power up).  
**Model 2400, 2401:** 190VA.

**COOLING:** Convection.

**EMC:** Conforms to European Union Directive 89/336/EEC, EN 61326-1.

**SAFETY: UL LISTED TO UL 61010B-1:2003:** Conforms to European Union Low Voltage Directive.

**VIBRATION:** MIL-PRF-28800F Class 3 Random.

**WARM-UP:** 1 hour to rated accuracies.

**DIMENSIONS:** 89mm high × 213mm wide × 370mm deep (3½ in × 8¾ in × 14½ in). **Bench Configuration (with handle and feet):** 104mm high × 238mm wide × 370mm deep (4¼ in × 9½ in × 14½ in).

**WEIGHT:** 3.21kg (7.08 lbs) (Model 2425, 2430, 2440: 4.1kg, 9.0 lbs).

**ENVIRONMENT: Operating:** 0°–50°C, 70% R.H. up to 35°C. Derate 3% R.H./°C, 35°–50°C.  
**Storage:** –25°C to 65°C.

Specifications are subject to change without notice.

All Keithley trademarks and trade names are the property of Keithley Instruments, Inc.  
 All other trademarks and trade names are the property of their respective companies.



A G R E A T E R M E A S U R E O F C O N F I D E N C E

KEITHLEY INSTRUMENTS, INC. ■ 28775 AURORA RD. ■ CLEVELAND, OH 44139-1891 ■ 440-248-0400 ■ Fax: 440-248-6168 ■ 1-888-KEITHLEY ■ www.keithley.com

**BELGIUM**  
 Sint-Pieters-Leeuw  
 Ph: 02-3630040  
 Fax: 02-3630064  
 info@keithley.nl  
 www.keithley.nl

**CHINA**  
 Beijing  
 Ph: 86-10-8447-5556  
 Fax: 86-10-8225-5018  
 china@keithley.com  
 www.keithley.com.cn

**FRANCE**  
 Saint-Aubin  
 Ph: 01-64532020  
 Fax: 01-60117726  
 info@keithley.fr  
 www.keithley.fr

**GERMANY**  
 Germering  
 Ph: 089-84930740  
 Fax: 089-84930734  
 info@keithley.de  
 www.keithley.de

**INDIA**  
 Bangalore  
 Ph: 080-26771071, -72, -73  
 Fax: 080-26771076  
 support\_india@keithley.com  
 www.keithley.com

**ITALY**  
 Peschiera Borromeo (Mi)  
 Ph: 02-5538421  
 Fax: 02-55384228  
 info@keithley.it  
 www.keithley.it

**JAPAN**  
 Tokyo  
 Ph: 81-3-5733-7555  
 Fax: 81-3-5733-7556  
 info.jp@keithley.com  
 www.keithley.jp

**KOREA**  
 Seoul  
 Ph: 82-2-574-7778  
 Fax: 82-2-574-7838  
 keithley@keithley.co.kr  
 www.keithley.co.kr

**MALAYSIA**  
 Penang  
 Ph: 60-4-643-9679  
 Fax: 60-4-643-3794  
 sea@keithley.com  
 www.keithley.com

**NETHERLANDS**  
 Gorinchem  
 Ph: 0183-635333  
 Fax: 0183-630821  
 info@keithley.nl  
 www.keithley.nl

**SINGAPORE**  
 Singapore  
 Ph: 65-6747-9077  
 Fax: 65-6747-2991  
 sea@keithley.com  
 www.keithley.com

**SWITZERLAND**  
 Zürich  
 Ph: 044-8219444  
 Fax: 044-8203081  
 info@keithley.ch  
 www.keithley.ch

**TAIWAN**  
 Hsinchu  
 Ph: 886-3-572-9077  
 Fax: 886-3-572-9031  
 info\_tw@keithley.com  
 www.keithley.com.tw

**UNITED KINGDOM**  
 Theale  
 Ph: 0118-9297500  
 Fax: 0118-9297519  
 info@keithley.co.uk  
 www.keithley.co.uk